

Operating
Manual

HP 3764A
Digital Transmission Analyzer

OPERATING MANUAL

HP 3764A

DIGITAL TRANSMISSION ANALYZER

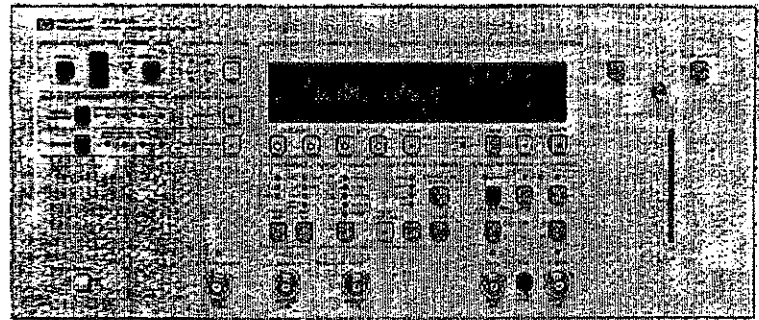

 HEWLETT
PACKARD

CERTIFICATION

Hewlett-Packard Company certifies that this product met its published specifications at the time of shipment from the factory. Hewlett-Packard further certifies that its calibration measurements are traceable to the United States National Bureau of Standards, to the extent allowed by the Bureau's calibration facility and to the calibration facilities of other International Standards Organization members.

WARRANTY

This Hewlett-Packard product is warranted against defects in materials and workmanship for a period of one year from date of shipment. During the warranty period, Hewlett-Packard Company will, at its option, either repair or replace products which prove to be defective.

For warranty service or repair, this product must be returned to a service facility designated by HP. Buyer shall prepay shipping charges to HP and HP shall pay shipping charges to return the product to Buyer. However, Buyer shall pay all shipping charges, duties, and taxes for products returned to HP from another country.

HP warrants that its software and firmware designated by HP for use with an instrument will execute its programming instructions when properly installed on that instrument. HP does not warrant that the operation of the instrument, or software, or firmware will be uninterrupted or error free.

LIMITATION OF WARRANTY

The foregoing warranty shall not apply to defects resulting from improper or inadequate maintenance by Buyer. Buyer-supplied software or interfacing, unauthorized modification or misuse, operation outside of the environment specifications for the products, or improper site preparation or maintenance.

NO OTHER WARRANTY IS EXPRESSED OR IMPLIED. HP SPECIFICALLY DISCLAIMS THE IMPLIED WARRANTIES OF MERCHANTABILITY AND FITNESS FOR A PARTICULAR PURPOSE.

EXCLUSIVE REMEDIES

THE REMEDIES PROVIDED HEREIN ARE BUYER'S SOLE AND EXCLUSIVE REMEDIES. HP SHALL NOT BE LIABLE FOR ANY DIRECT, INDIRECT, SPECIAL INCIDENTAL, OR CONSEQUENTIAL DAMAGES, WHETHER BASED ON CONTRACT, TORT, OR ANY OTHER LEGAL THEORY.

ASSISTANCE

Product maintenance agreements and other customer assistance agreements are available for Hewlett-Packard products.

For any assistance, contact your Hewlett-Packard Sales and Service Office. Addresses are provided at the back of this manual.

HP 3764A DIGITAL TRANSMISSION ANALYZER OPERATING MANUAL

SERIAL NUMBERS

This Manual applies directly to instruments with serial numbers prefixed 2847U.

© Copyright HEWLETT-PACKARD LIMITED 1989



HP Part No. 03764-90013
HP Fiche No. 03764-90038

Printed in UK July 1989

WARNING

READ THE FOLLOWING NOTES BEFORE INSTALLING OR SERVICING ANY INSTRUMENT.

1. IF THIS INSTRUMENT IS TO BE ENERGISED VIA AN AUTO-TRANSFORMER MAKE SURE THAT THE COMMON TERMINAL OF THE AUTO-TRANSFORMER IS CONNECTED TO THE NEUTRAL POLE OF THE POWER SOURCE.
2. THE INSTRUMENT MUST ONLY BE USED WITH THE MAINS CABLE PROVIDED. IF THIS IS NOT SUITABLE, CONTACT YOUR NEAREST HP SERVICE OFFICE. THE MAINS PLUG SHALL ONLY BE INSERTED IN A SOCKET OUTLET PROVIDED WITH A PROTECTIVE EARTH CONTACT. THE PROTECTIVE ACTION MUST NOT BE NEGATED BY THE USE OF AN EXTENSION CORD (POWER CABLE) WITHOUT A PROTECTIVE CONDUCTOR (GROUNDING).
3. BEFORE SWITCHING ON THIS INSTRUMENT:
 - (a) Make sure the instrument input voltage selector is set to the voltage of the power source.
 - (b) Ensure that all devices connected to this instrument are connected to the protective (earth) ground.
 - (c) Ensure that the line power (mains) plug is connected to a three-conductor line power outlet that has a protective (earth) ground. (Grounding one conductor of a two-conductor outlet is not sufficient).
 - (d) Check correct type and rating of the instrument fuse(s).

Contents

1. Operation	
Getting Started	1-3
Power On & Default Settings	1-3
Becoming Familiar with Front Panel Operation	1-4
Connecting the External Printer	1-5
Changing Front Panel Settings	1-5
Access Measurement Preset Store	1-5
Data Generation	1-6
Error Measurement	1-6
Configuring Results (External Printer)	1-7
Storing Front Panel Configuration in Measurement Preset Location 9	1-7
Verify Settings	1-7
Printing Results & Messages	1-8
Data Generation	1-10
Frequency	1-10
Frequency Selection (Std, Opts 001, 002, 003)	1-10
Frequency Selection (Opts 006, 007)	1-11
Selecting an Internal Frequency :-	1-11
Selecting Frequency Offsets :-	1-11
External Frequency & Termination Level	1-11
Generator Output Interface	1-12
Binary Interface (Std, Opts 001, 002, 003, 007)	1-12
Binary Interface (Opt 006)	1-12
Data Pattern	1-13
PRBS	1-13
Word	1-13
Alternate Word	1-14
AIS	1-15
Error Add	1-15
Jitter Generation	1-16
Frequency	1-16
Frequency Selection (Opt 002)	1-16
Frequency Selection (Opt 007)	1-16
Generator Output Interface	1-16
Internal Jitter Modulation	1-16
To Select & Set Internal Jitter Mask	1-17
External Jitter Modulation	1-18
Select & Set External Jitter	1-18
Thru Data (Option 007 Only)	1-19
Set Jitter Frequency & Amplitude	1-19
Internal Jitter Modulation	1-19
To Select & Set Internal Jitter Mask	1-19

External Jitter Modulation	1-20
To Select & Set External Jitter	1-21
To configure Thru Data for CMI	1-21
To Configure Thru Data for Binary	1-21
Delayed Data (Opt 003)	1-23
Error Measurement	1-24
Receiver Input Interface	1-24
Coded Data (CMI or HDB3)	1-24
Termination	1-24
Monitor	1-24
Binary Data (Std, Opts 001, 002, 003, 007)	1-24
Binary Data (Opt 006)	1-24
External Error	1-25
Frequency	1-25
Frequency Selection (Std, Opts 001, 002, 003)	1-25
Frequency Selection (Opts 006, 007)	1-26
Selecting Internal Frequency :-	1-26
Frequency Offsets	1-26
External Frequency & Termination Level	1-27
Pattern	1-27
PRBS	1-27
Word	1-28
AIS	1-29
Synchronization	1-29
Selecting Error Measurement Type	1-30
Selecting Error Performance Measurement Type	1-32
Thresholds	1-32
Jitter Measurement (Opts 002, 007)	1-34
Receiver Input Interface	1-34
Frequency	1-34
Frequency Selection (Opt 002)	1-34
Frequency Selection (Opts 007)	1-34
Jitter Measurement Type	1-35
Amplitude Range	1-35
Jitter Parameters	1-36
Jitter Reference Clock	1-36
Jitter Filters	1-36
Jitter Threshold	1-36
Jitter Gating	1-37
Manual Gating	1-37
Single Gating	1-38
Repetitive Gating	1-38
Measurement Preset & Keyboard Lock	1-39
Keyboard Lock	1-39
Measurement Preset Lock	1-39
Measurement Preset Store	1-40
Measurement Preset Recall	1-41
Flags	1-42
Auxiliary Inputs	1-43
Setting Time & Date	1-45
Printer	1-46

Connecting The External Printer	1-47
Configuring Results (External Printer)	1-48
Printing Results	1-49
Internal Printer	1-51
Configuring Results (Internal Printer)	1-51
Printing Results	1-53
Paper Roll Replacement (Internal Printer)	1-55
Ribbon Replacement (Internal Printer)	1-56
Tape Cartridge Unit (Opt 010)	1-57
Tape Initialization	1-57
Data Initialize	1-57
Settings Initialize	1-57
Tape Cartridge Measurement Messages	1-57
Configuring Results	1-59
Data Storage	1-60
Settings Storage	1-62
Recall Stored Data	1-62
Recall Stored Settings	1-62
General Information	1-62
Inserting/Removing Tape Cartridge	1-62
Write Protection	1-63
Tape Care	1-63
Tape Life	1-63
2. Making Measurements	
Key Measurement Parameters	2-2
Gating Period (Measurement Interval)	2-2
Synchronization	2-2
Error & Error Performance Measurements	2-4
Error Measurement Menu	2-4
Error Performance Measurement Menu	2-4
Basic Error Measurements	2-5
Binary Errors	2-5
External Errors	2-7
Clock Recovery Tolerance	2-8
565 Mbit/s Fibre Optic Error Measurement	2-10
Jitter Measurements	2-12
Jitter Measurement Menu	2-12
Basic Jitter Measurements	2-13
CMI Coded Data	2-13
Binary Clock	2-15
Jitter Tolerance Measurement	2-17
Jitter Transfer Measurement	2-19
De-Multiplexer Jitter Tolerance Measurement	2-21
A. Display/Error Messages	
B. Default Settings	
Index	

Figures

1-1. Thinkjet HP-IB Configuration Switch	1-5
1-2. Measurement Results & Messages	1-9
1-3. Thinkjet HP-IB Configuration Switch	1-47
1-4. Thinkjet Printout Of Measurement Results & Messages	1-50
1-5. Internal Printer Measurement Results & Messages	1-54
1-6. Paper Roll & Ribbon Cable	1-55
2-1. Measurement of Binary Errors on 139.264 Mbit/s Coded Data	2-5
2-2. Measurement of External Errors	2-7
2-3. 34.368 MHz Clock Recovery Tolerance Measurement	2-8
2-4. 565 Mbit/s Fibre Optic Measurement	2-10
2-5. Jitter Amplitude Measurement (139.264 Mbit/s CMI Data)	2-13
2-6. Jitter Hit Count (139.264 Mbit/s Binary Clock)	2-15
2-7. Jitter Tolerance Measurement	2-17
2-8. Jitter Transfer Measurement	2-19
2-9. De-Multiplexer Jitter Tolerance Measurement	2-21

Tables

1-1. Frequency Menu by Option	1-10
1-2. Frequency Vs Fixed Offset	1-11
1-3. PRBS Length Vs Data Rate	1-13
1-4. Jitter Frequency Vs Amplitude	1-16
1-5. Jitter Mask Example	1-17
1-6. Jitter Mod I/P (50 Ohm Unbalanced)	1-18
1-7. Jitter Frequency Vs Amplitude	1-19
1-8. Jitter Mask Example	1-19
1-9. Jitter Mod I/P (50 Ohm Unbalanced)	1-20
1-10. Frequency Menu by Option	1-25
1-11. Frequency vs Fixed Offset	1-26
1-12. PRBS Length Vs Data Rate	1-28
1-13. Amplitude Range Characteristics	1-35
1-14. Auxiliary Input Events	1-43
1-15. Printer Measurement Messages	1-46
1-16. Tape Cartridge Measurement Messages	1-58
A-1. Display/Error Messages	A-1
B-1. Default Settings	B-1

Operation

This section contains the information required to allow the user to become familiar with the operation of the HP 3764A to generate data, make measurements and obtain results.

GETTING STARTED

DATA GENERATION

- Frequency
- Generator Output Interface
- Pattern
- Error Add

JITTER GENERATION (Opts 002, 007)

- Frequency
- Generator Output Interface
- Internal Jitter Modulation
- External Jitter Modulation

THRU DATA (Opt 007)

- Jitter Generation
- Configure Thru Data

DELAYED DATA GENERATION (Opt 003)

ERROR MEASUREMENT

- Receiver Input Interface
- Frequency
- Pattern
- Synchronization
- Error Measurement Type
- Error Performance Measurement

JITTER MEASUREMENT (Opts 002, 007)

- Receiver Input Interface
- Frequency
- Jitter Measurement Type

MEASUREMENT PRESET & KEYBOARD LOCK

- Keyboard Lock
- Measurement Preset Lock
- Measurement Preset Store
- Measurement Preset Recall

FLAGS

AUXILIARY INPUTS

SETTING TIME & DATE

PRINTER

- Connecting The External Printer
- Configuring Results (External Printer)
- Internal Printer
- Configuring Results (Internal Printer)
- Paper Roll Replacement (Internal Printer)
- Ribbon Replacement (Internal Printer)

TAPE CARTRIDGE UNIT (Opt 010)

- Tape Initialization
- Tape Cartridge Messages
- Configuring Results
- Data Storage
- Settings Storage
- Recall Stored Data
- Recall Stored Settings
- General Information

APPENDIX A

- Display/Error Messages

APPENDIX B

- Default Settings

Getting Started

In this Getting Started section you will be shown how to set the HP 3764A to Default Settings, and become familiar with front panel operation.

You will be shown how to connect an HP Thinkjet (or similar) printer to the rear panel HP-IB connector.

You will be shown how to change the front panel settings and store these in a Measurement Preset location.

You will be shown how to recall the settings and output the Error Measurement results and messages to the printer.

Note



Full details and explanations of all Measurements, Messages, Front Panel settings, and capabilities of the HP 3764A covered in this Getting Started section can be found under the headings of *Data Generation; Error Measurement; Measurement Preset & Keyboard Lock; Printer.*

Power On & Default Settings

Ensure the Line Selector setting and fuse are correct for the power line in use and connect the HP 3764A to the line Supply.

Switch on the HP 3764A. The Parameters display will indicate SELF TEST (for approximately four seconds), followed by the error message POWER LOSS (C)HPLtd 88. A list of Display/Error Messages and an explanation of each is given in Appendix A.

Note



The front panel settings at switch on are those which were present before the last power down, not Default Settings.

Press [RECALL] until 0 appears in the Preset display.

The HP 3764A is now configured to its Default Settings, a full list of which can be found in Appendix B. The short list below is for use with this Getting Started chapter.

ERRORS MEASUREMENT	Error Ratio
GATING PERIOD/TYPE	Manual
GEN O/P INTERFACE	CMI
REC I/P INTERFACE	CMI/Term
FREQUENCY	139.264 Mbit/s (139M)
PATTERN	PRBS (2 ²³ -1)
SYNCHRONIZATION	Auto

Becoming Familiar with Front Panel Operation

Connect the GEN DATA OUTPUT to the REC DATA INPUT. (The REC DATA INPUT indicator should light.)

Connect the GEN CLOCK OUTPUT to the REC CLOCK INPUT. (The REC CLOCK INPUT indicator should light.)

Press [START/STOP GATING] to start the gating.

When the HP 3764A is gating, parameters can be viewed but any key which would normally change a measurement parameter is disabled.

Press [VIEW PATTERN] The pattern selected (PRBS 2[23]-1) will appear in the Parameters display. The pattern can be changed using [PATTERN] or [▲], [▼], [▶] & [◀] if the HP 3764A is not gating.

Press [PATTERN] An Audible BEEP will occur and the following message will appear in the Parameters display :-

NOT ALLOWED WHEN GATING

If you attempt to change any measurement parameter during gating, The **NOT ALLOWED WHEN GATING** message will appear, accompanied by an Audible BEEP. Try changing the following parameters :-

Parameter	Action
GEN O/P INTERFACE	Press [GEN O/P]
REC I/P INTERFACE	Press [REC I/P]
SYNCHRONIZATION	Press [SYNC]
GATING PERIOD/TYPE	Press [VIEW GATING PERIOD] to view Gating Parameters. Press [▲] to attempt to change Gating Parameters.
FREQUENCY	(Std, Opts 001, 002, 003) Press [FREQUENCY]. (Opts 006, 007) Press [FREQUENCY] to view Frequency Parameters. Press [▲] to attempt to change Frequency Parameters.

Note



1. During gating, actions which caused measurement parameters to be viewed were permitted.
2. During gating, actions which attempted to change a measurement parameter produced an Audible BEEP and a Parameters display of **NOT ALLOWED WHEN GATING**.

Since the HP 3764A makes all Error and Error Performance Measurements at the same time, the result displayed can be changed while the instrument is gating.

The result currently displayed is signalled by the appropriate indicator in the ERROR MEASUREMENT or ERROR PERFORM areas being lit. Currently the ERROR RATIO indicator is lit and the ERROR RATIO result is displayed

Binary Errors can be added to the generated data, using the ERROR ADD (SINGLE or 1/10³) facility, while gating is taking place.

Press [ERRORS MEASUREMENT]

The total ERROR COUNT, within the gating period will appear in the Results display(0).

Press [ERROR ADD SINGLE]

The ERROR COUNT result will increment by 1 each time [ERROR ADD SINGLE] is pressed.

Each of the Error Measurement & Error Performance results can be displayed in turn by pressing [ERRORS MEASUREMENT] & [ERROR PERFORM] even though the HP 3764A is gating..

Connecting the External Printer

To configure the HP Thinkjet printer to LISTEN ALWAYS :-

Switch OFF the power to the HP Thinkjet printer.

Set position 2 of the printer HP-IB configuration switch to "1" (Listen Always). All other switch positions are irrelevant in this configuration.

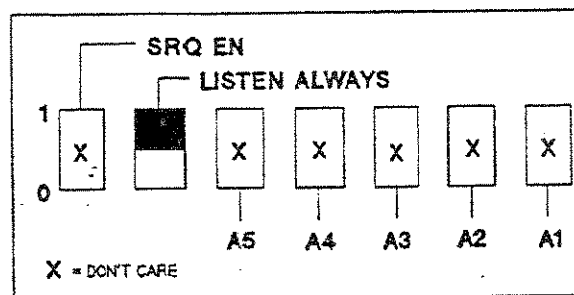

Figure 1-1. Thinkjet HP-IB Configuration Switch

Connect the HP Thinkjet printer to the HP 3764A rear panel HP-IB connector.

Changing Front Panel Settings

The Front Panel settings are changed and then the configuration is stored in a selected measurement preset location. Any location from 1 to 9 can be chosen. For this example, Measurement Preset location 9 will be used.

Access Measurement Preset Store

Press [SHIFT] then [RECALL] until PRESET 9 is flashing in the Parameters display

Note



Instruments with Serial No's below 2847U02888 implemented access to Measurement Preset STORE differently :-

Press [RECALL] until 9 appears in the Preset display

Data Generation

The Instrument will be set to generate RZ Binary Data, at a Frequency of 139.264 Mbit/s, with a Word Pattern of 01010101 01010101 :-

Press [GEN O/P] until the RZ indicator is lit

Press [PATTERN] until the WORD indicator is lit

Press [VIEW PATTERN]

Press [▶] & [▲] or [▼] until the Word Pattern is 01010101 01010101.

Press [FREQUENCY] until the 139M indicator is lit

Note

Options 006, 007 implement the Frequency function differently :-

Press [FREQUENCY] until the SOURCE indicator is lit

Press [▲] until INTERNAL is flashing in the Parameters display

Press [FREQUENCY] until the RATE indicator is lit

Press [▶] [▲] until FIXD 1 is flashing in the Parameters display (139.264 MHz)

Press [FREQUENCY] until the OFFSET indicator is lit

Press [▲] until OFF is flashing in the Parameters display

Error Measurement

The Instrument will be set to make Error Measurements on 139.264 Mbit/s Binary Data, with a Word Pattern of 01010101 01010101.

The Measurement will be made with Automatic Synchronization in a Repetitive Gating Period of 30 Seconds.

The result displayed will have been obtained during the current gating period.

If the Error ratio exceeds 1×10^{-4} in any "Available" second this will be considered a Severely Errorred Second. If this condition persists for more than 10 consecutive Seconds then a period of Unavailability will be signalled.

Press [REC I/P] until the BIN indicator is lit

Press [SYNC] until the AUTO indicator is lit

Press [VIEW GATING PERIOD]

Press [▶] until one of MANUAL, SINGLE or REP is flashing

Press [▲] until REP is flashing

Press [▶] & [▲] until CUR is flashing in the Parameters display

Press [▶] & [▼] until the Days setting is 00

Press [▶] & [▼] until the Hours setting is 00

Press [▶] & [▼] until the Minutes setting is 00

Press [▶] & [▲] or [▼] until the Seconds setting is 30

Press [VIEW THRESHOLD]

Press [▶] or [◀] until %UA %SES is flashing in the Parameters display

Press [▲] or [▼] until 10-4 is flashing in the Parameters display

Configuring Results (External Printer)

The Instrument mode must be set to Talk Only to enable results to be output to the External printer.

All 8 of the Error & Error Performance measurements will be output to the Printer, at the end of the gating period, if the Error Count is greater than 0 (C>0).

Any Error/Hit Seconds (EHS) will result in an EHS message being output to the Printer.

The state of the Auxiliary Inputs will not be output to the Printer (OFF).

Press [SHIFT] [LOCAL]

Press [▶] or [◀] until MODE is flashing

Press [▲] or [▼] until MODE & TALK ONLY are flashing

Press [▶] until FMT & one of ALW, C>0, R>N are flashing

Press [▲] until C>0 is flashing

Press [▶]

Press [▲] until EHS is flashing

Press [▶]

Press [▲] until OFF is flashing

Storing Front Panel Configuration in Measurement Preset Location 9

Press [SHIFT] then [RECALL]

Press [▶] until STORE is flashing in the Parameters display

Press [▲]

Note



Instruments with Serial No's below 2847U02888 implemented the STORE function differently :-

Press [SHIFT] then [RECALL]

Verify Settings

Press [RECALL] until 0 appears in the Preset display.

The front panel settings should be the default settings as detailed at the beginning of this Getting Started section.

Press [RECALL] until 9 appears in the Preset display

The front panel settings should be as set in the foregoing procedure.

Printing Results & Messages

It can be useful when making error Measurements to view the Elapsed Time within the Gating Period :-

Press [TIME] & [▶] until T^h is flashing in the Parameters display

The Elapsed Time is displayed in Days, Hours, Minutes, Seconds. As soon as gating is started the Elapsed Time will indicate 00,00,00,00 and then start counting until the end of the gating period is reached at which time it will revert to 00,00,00,00.

Action	Printed Result/Message
Press [START/STOP]	The Start message will be printed.
Toggle [ERROR ADD 1/10 ³] (IE. Press [ERROR ADD 1/10 ³] twice within a Second.)	Each time [ERROR ADD 1/10 ³] is toggled (Pressed twice within a second) an Error/Hit Second (EHS) message will be printed and at the end of the gating period (30 Seconds) all 8 Error & Error Performance measurements will be printed as the Error Count will be greater than 0 (C>0).
Press [START/STOP]	The Stop message, which includes measurement results, will be printed.
Press [START/STOP] & [ERROR ADD 1/10 ³]	The Start message will be printed. In addition an Error Hit message will be printed for each second the Errors are added. The EHS INHIBIT message will be printed 10 Seconds after [ERROR ADD 1/10 ³] is pressed. The UNAVAIL message will be printed when the Error Ratio is $> 1 \times 10^{-4}$ for 10 consecutive seconds.
Monitor the Elapsed Time and Press [ERROR ADD 1/10 ³] after 15 seconds have elapsed	The EHS RELEASE message will be printed when the first Error Free Second occurs. The AVAILABLE message will be printed when the Error Ratio is $< 1 \times 10^{-4}$ for 10 consecutive Seconds. At the end of the gating period all 8 Error & Error Performance measurements will be printed. Using the [ERROR ADD 1/10 ³] function to add errors will illustrate most of the Error & Error Performance measurement results. Only % Degraded Minutes gives NO RESULT as a gating period in excess of 1 Minute is required for that measurement. Full details of all the measurement messages available are listed in Table 1-8 under <i>Printer</i> .
Press [START/STOP]	The Stop message, which includes measurement results, will be printed.

Link Identification :
 Generator Location :
 Receiver Location :
 Gating Period : REPETITIVE LENGTH: 00D 00H 00M 30S
 Start : 22:16:17 16 FEB 84

RATE : 139 Mb/s
 PATTERN : 01010101 WRD
 01010101

TIME	UNAVAIL SECONDS	SEVERELY ERRORED SECONDS	DEGRADED MINUTES	ERRORED SECONDS	BIT ERROR RATIO	ERROR COUNT	ERROR SECONDS	ERROR FREE SECONDS
22:16:30		ERROR SECOND: NUMBER OF ERRORS (1.1E05)						
22:16:32		ERROR SECOND: NUMBER OF ERRORS (95570)						
22:16:34		ERROR SECOND: NUMBER OF ERRORS (95755)						
22:16:37		ERROR SECOND: NUMBER OF ERRORS (83765)						
22:16:38		ERROR SECOND: NUMBER OF ERRORS (14582)						
22:16:47		END PERIOD						
22:16:47	0.000%	16.67%	NO RSLT	16.67%	9.2E-05	3.8E05	5	25
22:16:51		STOP LENGTH OF GATING PERIOD: 00D 00H 00M 04S						
22:16:51	0.000%	0.000%	NO RSLT	0.000%	0	0	0	4

Link Identification :
 Generator Location :
 Receiver Location :
 Gating Period : REPETITIVE LENGTH: 00D 00H 00M 30S
 Start : 22:18:35 16 FEB 84

RATE : 139 Mb/s
 PATTERN : 01010101 WRD
 01010101

TIME	UNAVAIL SECONDS	SEVERELY ERRORED SECONDS	DEGRADED MINUTES	ERRORED SECONDS	BIT ERROR RATIO	ERROR COUNT	ERROR SECONDS	ERROR FREE SECONDS
22:18:36		ERROR SECOND: NUMBER OF ERRORS (64026)						
22:18:37		ERROR SECOND: NUMBER OF ERRORS (1.4E05)						
22:18:38		ERROR SECOND: NUMBER OF ERRORS (1.4E05)						
22:18:39		ERROR SECOND: NUMBER OF ERRORS (1.4E05)						
22:18:40		ERROR SECOND: NUMBER OF ERRORS (1.4E05)						
22:18:41		ERROR SECOND: NUMBER OF ERRORS (1.4E05)						
22:18:42		ERROR SECOND: NUMBER OF ERRORS (1.4E05)						
22:18:43		ERROR SECOND: NUMBER OF ERRORS (1.4E05)						
22:18:44		ERROR SECOND: NUMBER OF ERRORS (1.4E05)						
22:18:45		ERROR SECOND: NUMBER OF ERRORS (1.4E05)						
22:18:45		UNAVAIL						
22:18:46		EHS INHIBIT						
22:18:53		EHS RELEASE						
22:19:01		AVAILABLE						
22:19:05		END PERIOD						
22:19:05	53.33%	0.000%	NO RSLT	7.143%	5.2E-04	2.2E06	17	13
22:19:14		STOP LENGTH OF GATING PERIOD: 00D 00H 00M 08S						
22:19:14	0.000%	0.000%	NO RSLT	0.000%	0	0	0	8

Figure 1-2. Measurement Results & Messages

Data Generation

The HP 3764A can be configured to generate Coded Data, at pre-selected Bit rates, or Binary Data in the range 1 kbit/s to 170 Mbit/s. A selection of Data Patterns is available and Binary Errors can be added to the data if desired.

The Coded or Binary Data appears at the GEN DATA OUTPUT. The Clock signal from which the Data is derived is provided at the GEN CLOCK OUTPUT. A replica of the front panel Generator Clock is provided at the rear panel GEN CLK MON O/P.

Note



When a Jitter Option (Opts 002, 007) is fitted and the front panel GEN CLOCK OUTPUT is jittered, the rear panel GEN CLK MON O/P is not jittered.

Frequency

The HP 3764A allows selection from a frequency menu dependant upon the option fitted :-

Table 1-1. Frequency Menu by Option

Std/Opt 002/Opt 003	Opt 001	Opt 006	Opt 007
139.264 MHz	139.264 MHz	139.264 MHz	139.264 MHz
139.264 MHz +15 ppm	34.368 MHz	34.368 MHz	
139.264 MHz -15 ppm	8.448 MHz	8.448 MHz	
F2 Opt (1 MHz to 170 MHz)	2.048 MHz	2.048 MHz	
		704 kHz	
		VARB 1	VARB 1
		VARB 2	VARB 2
EXTERNAL	EXTERNAL	EXTERNAL	EXTERNAL

Frequency Selection (Std, Opts 001, 002, 003)

The Frequency required is selected from the menu :-

Press [FREQUENCY] until the indicator pertaining to the required frequency is lit.

If EXTERNAL is selected a Clock signal from an external source must be connected at the GEN EXT CLOCK INPUT.

The Input impedance of the GEN EXT CLOCK INPUT can be selected to be 75Ω to GND or 75Ω to -2V by means of a hardware wire link on the A5 Assembly.

The Triggering level can be selected to be Nominal GND, Nominal ECL or Nominal TTL by means of a hardware wire link on the A5 Assembly.

Caution



Information on the setting of these links can be found in the HP 3764A Service Manual A5 Assembly Service Sheet. This procedure should only be carried out by trained personnel aware of the safety hazards involved.

Frequency Selection (Opts 006, 007)

Selecting an Internal Frequency :-.

Press [FREQUENCY] until the SOURCE indicator is lit

Press [▶] or [◀] and [▲] until INTERNAL is flashing

Press [FREQUENCY] until the RATE indicator is lit

Press [▶] or [◀] and [▲] until RATE is flashing

The required frequency can be selected using [▶] & [▲] or [▼].

Note



If a Frequency Offset is already selected for any of the preset frequencies an asterisk (*) will be flashing on the parameters display alongside that frequency.

If VARB 1 or VARB 2 is selected then the frequency must be defined by the user :-

Press [▶] The frequency of the variable chosen will be flashing.

The frequency can be set in the range 1 kHz to 170 MHz. using [▲], [▼] and [▶], [◀].

Selecting Frequency Offsets :-.

Press [FREQUENCY] until the OFFSET indicator is lit

Press [▶] One of the following will be flashing. (OFF, +FIXED, -FIXED, VARIABLE 1, VARIABLE 2)

The Offset can now be selected using [▲] or [▼]. The value of the fixed Offset varies according to the frequency selected :-

Table 1-2. Frequency Vs Fixed Offset

Frequency	Fixed Offset
139.264 MHz	± 15 ppm
34.368 MHz	± 20 ppm
8.448 MHz	± 30 ppm
2.048 MHz	± 50 ppm
704 kHz	± 50 ppm
VARB 1	N/A
VARB 2	N/A

The Variable Offsets can be set in the range - 100 ppm to + 100 ppm :-

Press [◀] until the offset value is flashing

Press [▲] or [▼] to set the required Offset value.

External Frequency & Termination Level. To make an External Frequency selection and set the Termination Level of the GEN EXT CLOCK INPUT :-

Press [FREQUENCY] until the SOURCE indicator is lit

Press [▶] or [◀] and [▲] until EXTERNAL is flashing

Press [▶] One of the following terminations will be flashing (VAR GND, ECL GND, TTL GND, AUTO GND, ECL -2V, AUTO -2V)

The termination level of the GEN EXT CLOCK INPUT can now be selected using [▲] or [▼].

If VAR GND is selected then the voltage must be set :-

Press [▶] (Voltage value will be flashing)

Press [▲] or [▼] to set the voltage in the range -5.0 V to +5.0 V.

To view the frequency of the signal connected to the GEN EXT CLOCK INPUT :-

Press [FREQUENCY] until the RATE indicator is lit. The External Clock Input frequency will be displayed in the parameters display.

Generator Output Interface

The GEN O/P Interface allows selection between Coded Data and Binary Data.

Coded Data is CMI when the frequency selection is 139.264 Mbit/s (139M)
is HDB3 (Opts 001 & 006 Only) when the frequency selection is 34.368 Mbit/s (34M), 8.448 Mbit/s (8M), 2.048 Mbit/s (2M) or 704 kbit/s.

Binary Data can be either RZ (Return To Zero) or NRZ (Non Return To Zero).

Binary Interface (Std, Opts 001, 002, 003, 007)

When a Binary Interface is selected (RZ or NRZ) the termination level of the GEN DATA OUTPUT will be ECL if 139.264 Mbit/s (139M) is selected and TTL if 34.368 Mbit/s (34M), 8.448 Mbit/s (8M) or 2.048 Mbit/s (2M) is selected.

Binary Interface (Opt 006)

When a Binary Interface (RZ or NRZ) is selected the termination level of the GEN DATA OUTPUT can be set :-

Press [FREQUENCY] until the RATE indicator is lit

Press [◀] or [▶] and [▲] until I/FACE is flashing

Press [▶] and [▲] until GENER is flashing

Press [▶] (ECL or TTL will be flashing)

The termination level of the GEN DATA OUTPUT can be selected as ECL or TTL using [▲] or [▼].

Note

The termination level selected for the GEN DATA OUTPUT also determines the termination level of the REC DATA & CLOCK INPUT's.

Data Pattern

The Pattern key allows you to select PRBS, WORD, ALT WORD or AIS. PRBS, WORD and AIS apply to both the Generator and Receiver but ALT WORD only applies to the Generator. [VIEW PATTERN] allows the selected Pattern to be displayed in the Parameters display. The Pattern can then be changed, where appropriate, using [▲] or [▼].

PRBS

Two PRBS lengths are available ($2^{23}-1$) and ($2^{15}-1$). To obtain the PRBS selection :-

Press [PATTERN] until the PRBS indicator is lit.

Press [VIEW PATTERN]

The PRBS selection appears in the Parameters display and can be changed using [▲] or [▼].

Each time a PRBS Pattern is generated a Trigger pulse, 2 clock pulses wide, is provided at the rear panel GEN TRIG O/P.

Note

The CCITT recommendation for PRBS Length vs Data Rate is listed in Table 1-3.

Under CCITT recommendation G.703 the PRBS length is related to the Data Rate. If a PRBS length is selected which does not match the Data Rate selected then the PRBS indicator will flash. For example selecting $2^{15}-1$ in conjunction with 139.264 Mbit/s, will cause the PRBS indicator to flash.

Table 1-3. PRBS Length Vs Data Rate

Data Rate	PRBS Length
139.264 Mbit/s	$2^{23}-1$
34.368 Mbit/s	$2^{23}-1$
8.448 Mbit/s	$2^{15}-1$
2.048 Mbit/s	$2^{15}-1$

Word

The Word can be set to any length between 1 and 16 bits. Each bit can be set to 1 or 0.

Example : Set Word to 001100 (6 Bits). Then set Word length to 10 Bits.

Press [PATTERN] until the Word indicator is lit.

Press [VIEW PATTERN] (Word displayed - Bit 1 Top Left, Bit 16 Bottom Right)

Press [▶] or [◀] until Bit 1 is flashing.

Press [▲] or [▼] until a 0 appears in Bit 1 position.

Press [▶] until Bit 2 is flashing.

AIS

Alarm Indication Sequence (AIS) is displayed as an all 1's 16 Bit word and is obtained :-

Press [PATTERN] until the AIS indicator is lit.

Press [VIEW PATTERN] (Display - 16 Bit All 1's Word)

Error Add

Binary Errors can be added to the generated data.

Each time [ERROR ADD SINGLE] is pressed, one Binary Error is added to the data stream.

If [ERROR ADD 1/10³] is pressed Binary Errors are added at a rate of 1 in 1000 until [ERROR ADD 1/10³] is pressed again.

Jitter Generation

The HP 3764A can be configured to generate Jittered, CMI coded or Binary Data at 139.264 Mbit/s. The Jitter Modulation can be derived internally or from an external source.

Frequency

The Frequency must be set to 139.264 MHz for Jitter Generation.

Frequency Selection (Opt 002)

Press [FREQUENCY] until the 139M indicator is lit.

Frequency Selection (Opt 007)

Press [FREQUENCY] until the SOURCE indicator is lit.

Press [▶] or [◀] and [▲] until INTERNAL is flashing in the Parameters display.

Press [FREQUENCY] until the RATE indicator is lit.

Press [▶] or [◀] and [▲] until RATE is flashing.

Press [▶] then [▲] until FIXD1 is flashing.

Press [FREQUENCY] until the OFFSET indicator is lit.

Press [▲] or [▼] until OFF is flashing.

Generator Output Interface

The Generator Output Interface can be set to CMI, RZ or NRZ for Jitter Generation :-

Press [GEN O/P] until the required indicator is lit.

Internal Jitter Modulation

A range of Jitter Modulation frequencies is provided when Internal Jitter is selected. The permitted amplitude range varies according to the frequency selected.

Table 1-4. Jitter Frequency Vs Amplitude

Internal Frequency	Amplitude Range
100 Hz, 200 Hz, 500Hz, 1 kHz, 2 kHz, 5 kHz	0.0 UI to 10.0 UI in 0.1 UI steps
10 kHz, 20 kHz, 50 kHz, 100 kHz, 200 kHz, 500 kHz, 1 MHz, 2 MHz	0.00 UI to 1.00 UI in 0.01 UI steps
3.5 MHz	0.00 UI to 0.75 UI in 0.01 UI steps
4 MHz	0.00 UI to 0.50 UI in 0.01 UI steps

To Select & Set Internal Jitter Mask

The Internal jitter Mask can be set to include up to 16 Jitter frequency and amplitude points.

The following procedure sets up the 6 point mask detailed in Table 1-8 below :-

Table 1-5. Jitter Mask Example

Frequency	Amplitude	Frequency	Amplitude
100 Hz	4.5 UI	500 Hz	5.5 UI
10 kHz	0.75 UI	100 kHz	0.5 UI
1 MHz	0.25 UI	3.5 MHz	0.2 UI

Press [JITT GEN] until the INT MASK indicator is lit.

Press [FREQ/AMP] to view the Mask setting in the Parameters display.

The display shows four numerical parameters of the Mask

(Number of point)	PT xx OF xx	(Total number of points)
(Frequency of point)	F xxx kHz A xx.xx	(Amplitude of point)

Press [◀] or [▶] and [▲] or [▼] until the PT number is 1.

Press [▶] and [▲] or [▼] until OF number is 6.

Press [▶] and [▲] or [▼] until frequency setting is 100 Hz.

Press [▶], [◀], [▲], [▼] until amplitude setting is 4.5 UI.

Press [▶] and [▲] until PT 2 is flashing.

Press [▶] twice and [▲] until frequency setting is 500 Hz.

Press [▶], [◀], [▲], [▼] until amplitude setting is 5.5 UI.

Press [▶] and [▲] until PT 3 is flashing.

Press [▶] twice and [▲] until frequency setting is 10 kHz.

Press [▶], [◀], [▲], [▼] until amplitude setting is 0.75 UI.

Press [▶] and [▲] until PT 4 is flashing.

Press [▶] twice and [▲] until frequency setting is 100 kHz.

Press [▶], [◀], [▲], [▼] until amplitude setting is 0.5 UI.

Press [▶] and [▲] until PT 5 is flashing.

Press [▶] twice and [▲] until frequency setting is 1 MHz.

Press [▶], [◀], [▲], [▼] until amplitude setting is 0.25 UI.

Press [▶] and [▲] until PT 6 is flashing.

Press [▶] twice and [▲] until frequency setting is 3.5 MHz.

Press [▶], [◀], [▲], [▼] until amplitude setting is 0.2 UI.

The Mask can be stepped through, one point at a time, using [STEP].

External Jitter Modulation

If External Jitter is selected a Jitter Modulation signal from an external source must be connected to the front panel JITTER MOD I/P. Two ranges of External Jitter are provided 1 UI and 10 UI. The amplitude and frequency range accepted by the JITTER MOD I/P is detailed in Table 1-9.

Table 1-6. Jitter Mod I/P (50 Ohm Unbalanced)

Range	Amplitude	Frequency Range
1	0 to 1.15 UI	2 Hz to 2 MHz
1	0 to 0.75 UI	2 MHz to 3.5 MHz
1	0 to 0.5 UI	3.5 MHz to 5 MHz
10	0 to 11.5 UI	2 Hz to 100 kHz

Note



1. The maximum allowable input voltage is 10 V pk-pk.
 2. The nominal sensitivity on range 1 is 5 V/UI at 1 kHz and on range 10 is 0.5 V/UI at 1 kHz.
-

Select & Set External Jitter

Press [JITT GEN] until the EXT 1UI indicator is lit.

Press [FREQ/AMP] to view the Jitter setting in the Parameters display.

Connect a Jitter modulation signal from an External source to the JITTER MOD I/P.

Adjust the amplitude of the Jitter modulation source to obtain the required amplitude as displayed in the parameters display. (5 V pk-pk is nominally required at 1 kHz to provide 1 UI of Jitter.)

If greater than 1 UI of Jitter is required then select EXT 10UI. (0.5 V pk-pk is nominally required at 1 kHz to provide 1 UI of Jitter.)

Thru Data (Option 007 Only)

The Thru Data function allows the user to add jitter to 139.264 Mbit/s traffic. To use the Thru Data function you require to set the jitter generator to the Frequency and Amplitude of jitter you intend to add to the 139.264 Mbit/s data. You must then enable and configure the Thru Data function.

Set Jitter Frequency & Amplitude

The jitter to be added to the data can be derived from an internal or external source.

Internal Jitter Modulation

A range of Jitter Modulation frequencies is provided when Internal Jitter is selected. The permitted amplitude range varies according to the frequency selected.

Table 1-7. Jitter Frequency Vs Amplitude

Internal Frequency	Amplitude Range
100 Hz, 200 Hz, 500Hz, 1 kHz, 2 kHz, 5 kHz	0.0 UI to 10.0 UI in 0.1 UI steps
10 kHz, 20 kHz, 50 kHz, 100 kHz, 200 kHz, 500 kHz, 1 MHz, 2 MHz	0.00 UI to 1.00 UI in 0.01 UI steps
3.5 MHz	0.00 UI to 0.75 UI in 0.01 UI steps
4 MHz	0.00 UI to 0.50 UI in 0.01 UI steps

To Select & Set Internal Jitter Mask. The Internal jitter Mask can be set to include up to 16 Jitter frequency and amplitude points.

The following procedure sets up the 6 point mask detailed in Table 1-5 below :-

Table 1-8. Jitter Mask Example

Frequency	Amplitude	Frequency	Amplitude
100 Hz	4.5 UI	500 Hz	5.5 UI
10 kHz	0.75 UI	100 kHz	0.5 UI
1 MHz	0.25 UI	3.5 MHz	0.2 UI

Press [JITT GEN] until the INT MASK indicator is lit.

Press [FREQ/AMP] to view the Mask setting in the Parameters display.

The display shows four numerical parameters of the Mask

(Number of point) PT xx OF xx (Total number of points)
(Frequency of point) F xxx kHz A xx.xx (Amplitude of point)

Press [◀] or [▶] and [▲] or [▼] until the PT number is 1.

Press [▶] and [▲] or [▼] until OF number is 6.

Press [▶] and [▲] or [▼] until frequency setting is 100 Hz.

Press [▶], [◀], [▲], [▼] until amplitude setting is 4.5 UI.
 Press [▶] and [▲] until PT 2 is flashing.
 Press [▶] twice and [▲] until frequency setting is 500 Hz.
 Press [▶], [◀], [▲], [▼] until amplitude setting is 5.5 UI.
 Press [▶] and [▲] until PT 3 is flashing.
 Press [▶] twice and [▲] until frequency setting is 10 kHz.
 Press [▶], [◀], [▲], [▼] until amplitude setting is 0.75 UI.
 Press [▶] and [▲] until PT 4 is flashing.
 Press [▶] twice and [▲] until frequency setting is 100 kHz.
 Press [▶], [◀], [▲], [▼] until amplitude setting is 0.5 UI.
 Press [▶] and [▲] until PT 5 is flashing.
 Press [▶] twice and [▲] until frequency setting is 1 MHz.
 Press [▶], [◀], [▲], [▼] until amplitude setting is 0.25 UI.
 Press [▶] and [▲] until PT 6 is flashing.
 Press [▶] twice and [▲] until frequency setting is 3.5 MHz.
 Press [▶], [◀], [▲], [▼] until amplitude setting is 0.2 UI.

The Mask can be stepped through, one point at a time, using [STEP].

External Jitter Modulation

If External Jitter is selected a Jitter Modulation signal from an external source must be connected to the front panel JITTER MOD I/P. Two ranges of External Jitter are provided 1 UI and 10 UI. The amplitude and frequency range accepted by the JITTER MOD I/P is detailed in Table 1-6.

Table 1-9. Jitter Mod I/P (50 Ohm Unbalanced)

Range	Amplitude	Frequency Range
1	0 to 1.15 UI	2 Hz to 2 MHz
1	0 to 0.75 UI	2 MHz to 3.5 MHz
1	0 to 0.5 UI	3.5 MHz to 5 MHz
10	0 to 11.5 UI	2 Hz to 100 kHz

Note



1. The maximum allowable input voltage is 10 V pk-pk.
2. The nominal sensitivity on range 1 is 5 V/UI at 1 kHz and on range 10 is 0.5 V/UI at 1 kHz.

To Select & Set External Jitter.

Press [JITT GEN] until the EXT 1UI indicator is lit.

Press [FREQ/AMP] to view the Jitter setting in the Parameters display.

Connect a Jitter modulation signal from an External source to the JITTER MOD I/P.

Adjust the amplitude of the Jitter modulation source to obtain the required amplitude as displayed in the parameters display. (5 V pk-pk is nominally required at 1 kHz to provide 1 UI of Jitter.)

If greater than 1 UI of Jitter is required then select EXT 10UI. (0.5 V pk-pk is nominally required at 1 kHz to provide 1 UI of Jitter.)

To configure Thru Data for CMI

Connect the 139.264 Mbit/s data to the Thru Data DATA INPUT.

Press [CONFIGURATION]

DATA FORMAT will be flashing in the top row of the Parameters display. CMI, BIN TRUE CLK or BIN INV CLK will be flashing in the bottom row of the Parameters display.

Press [▶] or [◀] and [▲] or [▼] until CMI is flashing in the bottom row of the Parameters display.

Press [ENABLE] (The SIGNAL PRESENT indicator should light after a few seconds).

139.264 Mbit/s CMI coded Data with jitter added at the frequency & amplitude selected on the jitter generator is present at the Thru Data DATA OUTPUT.

Note



OVERFLOW indicates that the data has "slipped" and the instrument will automatically correct. Any measurements made while the OVERFLOW indicator is lit are invalid.

To Configure Thru Data for Binary

Connect the 139.264 Mbit/s Binary Data to Thru Data DATA INPUT.

Connect the 139.264 MHz Binary Clock to Thru Data CLOCK INPUT.

Press [CONFIGURATION]

DATA FORMAT will be flashing in the top row of the Parameters display. CMI, BIN TRUE CLK or BIN INV CLK will be flashing in the bottom row of the Parameters display.

Press [▶] or [◀] and [▲] or [▼] until BIN TRUE CLK is flashing in the bottom row of the Parameters display.

Press [ENABLE] (The SIGNAL PRESENT indicator should light after a few seconds).

Note

If the SIGNAL PRESENT indicator does not light then using [▲] & [▶] select BIN INV CLK.

139.264 Mbit/s Binary Data with jitter added at the frequency & amplitude selected on the jitter generator is present at the Thru Data DATA OUTPUT.

Note

OVERFLOW indicates that the data has "slipped" and the instrument will automatically correct. Any measurements made while the OVERFLOW indicator is lit are invalid.

Delayed Data (Opt 003)

The Delayed Data option provides an additional three 139.264 Mbit/s Data Outputs which are located on the HP 3764A rear panel. These three outputs are replica's of the front panel Generator DATA O/P delayed by a defined amount. The Data will be CMI or Binary (RZ or NRZ) according to the front panel selection. The amount of delay added is defined with respect to the PRBS sequence :-

- | | |
|------------|---|
| DATA O/P 1 | Delayed by half a sequence length ($\pm 1/2$ bit) with respect to the front panel GEN DATA OUTPUT. |
| DATA O/P 2 | Delayed by >1 bit with respect to DATA O/P 1. |
| DATA O/P 3 | Delayed by >1 bit with respect to DATA O/P 2. |

Error Measurement

The HP 3764A can be configured to detect Binary Errors present at the REC DATA INPUT, or to count External Errors present at the REC DATA INPUT.

Each time an Error is detected at the REC DATA INPUT the Error/Hits indicator on the front panel will be lit momentarily.

Receiver Input Interface

The Receiver Input Interface allows selection from :-

Coded Data (TERM & MON)

Binary Data (BIN)

External Errors (EXT ERR)

Coded Data (CMI or HDB3)

Termination. When TERM is selected the REC DATA INPUT accepts Coded Data. The data is CMI Coded when the Frequency selection is 139.264 MHz (139M) and HDB3 Coded (Opts 001 & 006 Only) when the Frequency selection is 34.368 MHz (34M), 8.448 MHz (8M), 2.048 MHz (2M) or 704 kHz.

When TERM is selected it is not necessary to input a clock signal to the REC CLOCK INPUT as the clock is recovered from the received data. The recovered clock signal is provided at the rear panel REC CLK O/P.

Automatic Equalization for cable losses up to 12 dB, at half bit rate, is provided by this input.

Monitor. When MON is selected the Coded Data must be connected to the REC MONITOR DATA INPUT.

When MON is selected it is not necessary to input a clock signal to the REC CLOCK INPUT as the clock is recovered from the received data. The recovered clock is provided at the rear panel REC CLK O/P.

Additional gain of 26dB to allow for flat loss at equipment monitor points, and automatic equalization for cable losses up to 12dB at half Bit rate are provided by this input.

Binary Data (Std, Opts 001, 002, 003, 007)

When BIN is selected a clock signal must be provided at the REC CLOCK INPUT as clock recovery is not provided. This clock signal will appear at the rear panel REC CLK O/P. The REC DATA INPUT will accept Binary RZ or NRZ data at a rate of 1 kbit/s to 170 Mbit/s.

The termination level of the REC DATA & CLOCK INPUT's is TTL unless 139M is selected when it will be ECL.

Binary Data (Opt 006)

When BIN is selected a clock signal must be provided at the REC CLOCK INPUT as Clock recovery is not provided. This clock signal will appear at the rear panel REC CLK O/P. The REC DATA INPUT will accept Binary RZ or NRZ data at a rate of 1 kbit/s to 170 Mbit/s.

The termination level of the REC DATA & CLOCK INPUT's can be selected :-

Press [FREQUENCY] until the RATE indicator is lit

Press [◀] or [▶] and [▲] until I/FACE is flashing

Press [▶] and [▲] until RCVR is flashing

Press [▶] (ECL or TTL will be flashing)

The termination level of the REC DATA & CLOCK INPUT's can now be selected as ECL or TTL using [▲] or [▼].

Note

The termination level selected for the REC DATA & CLOCK INPUT's also determines the termination level of the GEN DATA OUTPUT.

External Error

When EXT ERR is selected the REC DATA INPUT will accept Binary Errors from an External source at ECL levels.

An input must be provided at the REC CLOCK INPUT as Clock Recovery is not possible.

Frequency

The HP 3764A allows selection from a frequency menu dependant upon the option fitted :-

Table 1-10. Frequency Menu by Option

Std/Opt 002/Opt 003	Opt 001	Opt 006	Opt 007
139.264 MHz	139.264 MHz	139.264 MHz	139.264 MHz
139.264 MHz +15 ppm	34.368 MHz	34.368 MHz	
139.264 MHz -15 ppm	8.448 MHz	8.448 MHz	
F2 Opt (1 MHz to 170 MHz)	2.048 MHz	2.048 MHz	
		704 kHz	
		VARB 1	VARB 1
		VARB 2	VARB 2
EXTERNAL	EXTERNAL	EXTERNAL	EXTERNAL

Frequency Selection (Std, Opts 001, 002, 003)

The Frequency required is selected from the menu :-

Press [FREQUENCY] until the required frequency indicator is lit.

If EXTERNAL is selected a Clock signal from an external source must be connected at the GEN EXT CLOCK INPUT.

The Input impedance of the GEN EXT CLOCK INPUT can be selected to be 75Ω to GND or 75Ω to -2V by means of a hardware wire link on the A5 Assembly.

The triggering level can be selected to be Nominal GND, Nominal ECL or Nominal TTL by means of a hardware wire link on the A5 Assembly.

Caution

Information on the setting of these links can be found in the HP 3764A Service Manual A5 Assembly Service Sheet. This procedure should only be carried out by trained personnel aware of the safety hazards involved.

Frequency Selection (Opts 006, 007)**Selecting Internal Frequency :-**

Press [FREQUENCY] until the SOURCE indicator is lit

Press [▶] or [◀] and [▲] until INTERNAL is flashing

Press [FREQUENCY] until the RATE indicator is lit

Press [▶] or [◀] and [▲] until RATE is flashing

The required frequency can be selected using [▶] and [▲]

Note

If a Frequency Offset is already selected for any of the preset frequencies an asterisk (*) will be flashing on the parameters display alongside that frequency.

If VARB 1 or VARB 2 is selected then the frequency must be defined by the user :-

Press [▶] The frequency of the variable chosen will be flashing.

The frequency can be set in the range 1 kHz to 170 MHz using [▲], [▼] and [▶], [◀].

Note

If a Frequency below 500 KHz is selected then AUTO Synchronization is not valid and EXT or MAN Synchronization should be selected.

Frequency Offsets. If a Frequency Offset is required :-

Press [FREQUENCY] until the OFFSET indicator is lit

Press [▶] (One of the following will be flashing :- OFF, + FIXED, - FIXED, VARIABLE 1, VARIABLE 2)

The Offset can now be selected using [▲] or [▼]. The value of the fixed Offset varies according to the frequency selected :-

Table 1-11. Frequency vs Fixed Offset

Frequency	Fixed Offset
139.264 MHz	± 15 PPM
34.368 MHz	± 20 PPM
8.448 MHz	± 30 PPM
2.048 MHz	± 50 PPM
704 kHz	± 50 PPM
VAR 1	N/A
VAR 2	N/A

The Variable Offsets can be set in the range -100 ppm to +100 ppm :-

Press [◀] until the offset value is flashing

Press [▲] or [▼] to set the required Offset value.

External Frequency & Termination Level. To make an External Frequency selection and set the termination Level of the GEN EXT CLOCK INPUT :-

Press [FREQUENCY] until the SOURCE indicator is lit

Press [▶] or [◀] and [▲] until EXTERNAL is flashing

Press [▶] One of the following terminations will be flashing (VAR GND, ECL GND, TTL GND, AUTO GND, ECL -2V, AUTO -2V)

The termination level of the GEN EXT CLOCK INPUT can now be selected using [▲] or [▼].

If VAR GND is selected then the voltage must be set :-

Press [▶] (Voltage value will be flashing)

Press [▲] or [▼] to set the voltage in the range -5.0 V to +5.0 V.

To view the frequency of the signal connected to the GEN EXT CLOCK INPUT :-

Press [FREQUENCY] until the RATE indicator is lit. The EXT CLOCK I/P frequency will be displayed in the parameters display.

Pattern

The Pattern key allows you to select PRBS, WORD, ALT WORD or AIS. ALT WORD is only applicable to the Generator. Pressing [VIEW PATTERN] allows you to display the selected pattern in the Parameters display. The pattern can then be changed using [▲] or [▼].

PRBS

Two PRBS lengths are available ($2^{23}-1$) and ($2^{15}-1$). To obtain the PRBS selection :-

Press [PATTERN] until the PRBS indicator is lit.

Press [VIEW PATTERN]

The PRBS selection appears in the Parameters display and can be changed using [▲] or [▼].

Each time a Receiver PRBS Pattern occurs a Trigger pulse, 2 clock pulses wide, is provided at the rear panel REC TRIG O/P.

Note



The CCITT recommendation for PRBS Length vs Data Rate is listed in Table 1-12.

Under CCITT recommendation G.703 the PRBS length is related to the Data Rate. If a PRBS length is selected which does not match the Data Rate then the PRBS indicator will flash. For example, selecting $2^{15}-1$ in conjunction with 139.264 Mbit/s will cause the PRBS indicator to flash.

Press [▲] or [▼] until a - appears in Bit positions 11 to 16.

Each time a Receiver Word Pattern occurs a Pattern Trigger output signal is provided at the rear panel REC TRIG O/P. The Trigger pulse is 2 clock pulses wide and coincides with the start of the WORD.

AIS

Alarm Indication Sequence (AIS) is displayed as an all 1's 16 Bit word and is obtained :-

Press [PATTERN] until the AIS indicator is lit.

Press [VIEW PATTERN] (Display - 16 Bit All 1's Word)

Synchronization

When making error measurements it is necessary for the HP 3764A Receiver pattern and the generated pattern to be in Synchronization. Three methods of Synchronization are available :-

Automatic (AUTO)

AUTO Sync is selected by pressing [SYNC] until the AUTO indicator is lit. The instrument will carry out Sync Searches until Synchronization (Sync Gain) is achieved.

When Sync Gain has been achieved (<10 Errors in 90 Clocks) the instrument will monitor the received data for Sync Loss (>10,000 Errors in 90,000 Clocks).

When Sync Loss is detected, the instrument will, halt the measurement in progress, clear the measurement counters, initiate a Sync Search, and indicate Sync Loss by means of a FLAG in the Flags Display. Sync Search will be repeated if necessary until Sync Gain is achieved.

External (EXT)

EXT Sync is selected by pressing [SYNC] until the EXT indicator is lit. A Sync Search can only be initiated by applying a pulse to the rear panel EXT SYNC INPUT (ECL, Logic 0 to 1 transition, > 20ns wide). Sync Search will be repeated if necessary until Sync Gain is achieved.

When Sync Gain is achieved Sync Loss will not occur irrespective of the measured Error rate. The measurement will therefore continue without initiating a Sync Search until a pulse is applied to the EXT SYNC INPUT.

This is of benefit when making measurements on a system suffering irregular long bursts of Errors.

Manual (MAN)

MAN Sync is selected by pressing [SYNC] until the MAN indicator is lit. A Sync Search will only be initiated by pressing [MAN]. Sync Search will be repeated if necessary until Sync Gain is achieved.

When Sync Gain is achieved Sync Loss will not occur irrespective of the measured Error rate. The measurement will therefore continue without a Sync Search being initiated until [MAN] is pressed.

This is of benefit when making measurements on a system suffering irregular long bursts of Errors.

Selecting Error Measurement Type

The Error Measurement Result to be displayed (in the Results display) is selected by [ERRORS]. The Error Measurement Types available are :-

ERROR RATIO	Ratio of counted errors to number of clock periods in the gating period.
ERROR COUNT	Total number of errors within the gating period.
ERROR SECONDS	Number of seconds which contain at least 1 error.
ERROR FREE SECONDS	Number of seconds which contain 0 errors.

Each time an error occurs, a pulse is provided at the rear panel ERROR/HITS O/P. If Data Loss is detected the ERROR/HITS O/P will give a continuous stream of pulses. If SYNC LOSS is detected the ERROR/HITS O/P will give a pulse equivalent to every other bit in error.

Before any result can be displayed a gating period must be selected. The types of gating available are :-

MANUAL	Gating starts when [START/STOP] is pressed and stops when [START/STOP] is next pressed.
SINGLE	Gating starts when [START/STOP] is pressed and stops when the user specified gating period ends or when [START/STOP] is next pressed.
REPETITIVE	Gating starts when [START/STOP] is pressed. Each time the end of the user specified gating period is reached the gating automatically repeats. The gating stops when [START/STOP] is next pressed.

The following procedure shows you how to make an ERROR RATIO measurement with MANUAL gating.

Connect the GEN DATA OUTPUT to the RX DATA INPUT.

Press [RECALL] until 0 appears in the MEAS PRESET display.

Press [GATING PERIOD] (MANUAL flashing in Parameters display)

Press [START/STOP] (Results display - 0)

Press [ERROR ADD SINGLE] (Results display will change)

Note



1. The gating will continue until [START/STOP] is pressed.
 2. The other error measurement results can be displayed by pressing [ERRORS].
 3. The elapsed gating time may be viewed by pressing [VIEW TIME] and using [▶] or [◀] until T^v is flashing. The elapsed gating time is displayed in days, hours, minutes, seconds.
-

Press [START/STOP] (Halts gating)

Press [ERRORS] until the ERROR RATIO indicator is lit.

You will now change gating to SINGLE and set the gating period to 45 seconds.

Press [▲] (SINGLE flashing in Parameters display)

Press [▶] (Days setting flashing 00)

Press [▶] (Hours setting flashing 00)

Press [▶] (Minutes setting flashing 00)

Press [▶] (Seconds setting flashing 00)

Press [▲] until the Seconds setting is 45.

Press [START/STOP] (Results display 0)

Press [ERROR ADD SINGLE] (Results display will change)

Note



1. The gating will continue until 45 Seconds have elapsed and then stop.
 2. The other error measurement results can be displayed by pressing [ERRORS].
 3. The elapsed gating time may be viewed by pressing [VIEW TIME] and using [▶] or [◀] until T^v is flashing. The elapsed gating time is displayed in days, hours, minutes, seconds.
-

You will now change gating to REPETITIVE, set the gating period to 5 seconds and select PREVIOUS or CURRENT result.

Press [▶] until SINGLE is flashing in the Parameters display.

Press [▲] (REP flashing)

Press [▶] (PRV flashing)

Press [▶] (Days setting flashing 00)

Press [▶] (Hours setting flashing 00)

Press [▶] (Minutes setting flashing 00)

Press [▶] (Seconds setting flashing 45)

Press [▼] until Seconds setting is 05.

Press [START/STOP] (Results display 0)

Note



1. At the end of each gating period a new gating period will begin. This will continue until [START/STOP] is pressed.
 2. The other error measurement results can be displayed by pressing [ERRORS].
 3. The elapsed gating time may be viewed by pressing [VIEW TIME] and using [▶] or [◀] until T^v is flashing. The elapsed gating time is displayed in days, hours, minutes, seconds.
-

Press [ERROR ADD SINGLE]

Since the PREVIOUS gating period (PRV) is selected the effect of adding errors will not appear in the Results display until the end of the gating period.

Press [▶] (REP flashing)

Press [▶] (PRV flashing)

Press [▲] or [▼] (CUR flashing)

Press [ERROR ADD SINGLE]

Since the CURRENT gating period (CUR) is selected the effect of adding Errors will appear in the Results display immediately.

Selecting Error Performance Measurement Type

The Error Performance Measurement result to be displayed (in the Results display) is selected by [ERROR PERFORM]. The Error Performance Measurements available are :-

- %UNAVAIL** is the ratio of 1 second intervals when the system was considered "Unavailable" to the total second count during the Gating period. A period of "Unavailability" begins when the BER in each second is worse than 1×10^{-3} for 10 consecutive seconds. Those 10 seconds are considered "Unavailable". The period of "Unavailability" terminates when the BER in each second is better than 1×10^{-3} for 10 consecutive seconds. Those 10 seconds are considered "Available".
- %SES** is the ratio of 1 second intervals exhibiting a BER worse than 1×10^{-3} during the "Available" period to the total "Available" second count within the Gating period.
- %DM** is the ratio of "Packaged Minutes" exhibiting a BER worse than 1×10^{-6} to the total "Packaged Minute" count within the Gating period. A "Packaged Minute" is a grouping of 60 seconds which does not include Severely Errorred second or periods of Unavailability.
- %ES** is the ratio of 1 second intervals containing at least 1 error during the "Available" time to the total "Available" second count within the Gating period.

Thresholds

The Thresholds quoted above for % UNAVAIL, % SES and % DM are the default settings adopted by the HP 3764A at switch-on and correspond to CCITT recommendation G.821. The Thresholds can be changed to other settings in which case the relevant indicator (%UNAVAIL, %SES or %DM) will flash to signify departure from CCITT recommendation.

The % UNAVAIL and % SES Threshold can be set in the range 1×10^{-1} to 1×10^{-6} (Default 1×10^{-3}) :-

Press [VIEW THRESHOLD] (Threshold parameters will appear in Parameters display).

Press[▶] or [◀] until %UA %SES is flashing in the Parameters display.

Press [▲] or [▼] to change the Threshold value as required.

The % DM Threshold can be set in the range 1×10^{-3} to 1×10^{-9} (Default 1×10^{-6}) :-

Press [VIEW THRESHOLD] (Threshold parameters will appear in Parameters display).

Press [▶] or [◀] until %DM is flashing in the Parameters display.

Press [▲] or [▼] to change the Threshold value as required.

Before any of the Error Performance Measurement results can be displayed a Gating period must be set as is the case for Error Measurement. Three types of Gating are available :-

MANUAL

Gating starts when [START/STOP] is pressed and stops when [START/STOP] is next pressed.

SINGLE

Gating starts when [START/STOP] is pressed and stops when the user specified Gating Period ends or when [START/STOP] is next pressed.

REPETITIVE

Gating starts when [START/STOP] is pressed. Each time the end of the user specified Gating Period is reached the gating automatically repeats. The gating stops when [START/STOP] is next pressed.

The Gating is set using [▶] or [◀] to access the parameter and [▲] or [▼] to change the value as detailed in Error Measurement Type.

Note



1. When making a % UNAVAIL measurement the Gating period must be set greater than 10 Seconds as the "Availability" decision is based on a 10 Second period.
 2. When making a % DM measurement the Gating period must be set to greater than 1 Minute and would typically be set to several Minutes.
-

Jitter Measurement (Opts 002, 007)

Jitter can be measured on a Clock recovered from 139.264 Mbit/s CMI coded data present at the REC DATA INPUT or on 139.264 MHz clock present at the REC CLOCK INPUT.

The reference (unjittered) clock can be provided internally or supplied from an external source to the rear panel JITT REF CLK I/P.

Demodulated Jitter can be measured via the rear panel JITT MEAS I/P. The sensitivity of this input varies according to the Jitter Amplitude range selected :-

AMPL RANGE 1 UI :- 0.2 UI/V

AMPL RANGE 10 UI :- 2 UI/V

Receiver Input Interface

The Receiver Input Interface allows you to select between :-

Coded Data (TERM & MON)

Binary Data (BIN)

External Errors (EXT ERR). EXT ERR is not valid during Jitter Measurement.

The Receiver Input Interface selection depends upon the nature of the Jittered signal :-

Interface Selection	Jittered Signal Type
TERM	When Jitter is to be measured on a Clock recovered from CMI coded data presented at the REC DATA INPUT.
MON	When Jitter is to be measured on a Clock recovered from CMI coded Data presented at the REC MON DATA INPUT.
BIN	When Jitter is to be measured on a Clock presented at the REC CLOCK INPUT.

Frequency

Jitter measurements can only be made at a frequency of 139.264 MHz (139M).

Frequency Selection (Opt 002)

Press [FREQUENCY] until the 139M indicator is lit.

Frequency Selection (Opts 007)

Press [FREQUENCY] until the SOURCE indicator is lit.

Press [▶] or [◀] and [▲] until INTERNAL is flashing in the Parameters display.

Press [FREQUENCY] until the RATE indicator is lit.

Press [▶] or [◀] and [▲] until RATE is flashing.

Press [▶] then [▲] until FIXD1 is flashing.

Press [FREQUENCY] until the OFFSET indicator is lit.

Press [▲] or [▼] until OFF is flashing.

Jitter Measurement Type

All of the Jitter Measurements available are made simultaneously. The [JITT MEAS] key allows selection of the Jitter result to be displayed in the Results display :-

- PK-PK MAX** is maximum value of pk-pk Jitter measured over the selected gating period.
- JITTER HIT COUNT** is the number of times the measured jitter amplitude exceeds a user-set Threshold.
- JITTER HIT SECONDS** is the number of seconds in which the measured jitter amplitude exceeds a user-set Threshold.
- JITTER HIT FREE SECONDS** is the number of seconds in which the measured jitter amplitude does NOT exceed a user-set Threshold.

The jitter signal, demodulated from the CMI coded data or from the binary clock, is output to the rear panel DEMOD JITT O/P. This allows the jitter spectrum to be viewed on a Spectrum Analyzer or the rms value of the jitter to be measured. The amplitude of this output varies according to the Jitter Amplitude range selected :-

AMPL RANGE 1 UI 5.0 V/UI pk-pk

AMPL RANGE 10 UI 0.5 V/UI pk-pk

If the pk-pk amplitude of the measured jitter is outside the selected Amplitude range then "or" appears in the Results display.

If the jitter measurement is being made on a Clock presented at the REC CLOCK INPUT and the Clock Loss Flag occurs then "-----cl" appears in the Results display.

If a Jitter Hit occurs, irrespective of which jitter measurement is selected, the Error/Hits indicator on the front panel will be lit momentarily.

Each time an Error/Hit occurs a pulse is provided at the rear panel ERROR/HITS O/P.

Amplitude Range

The measured Jitter Amplitude range can be selected as 1 UI or 10 UI using [AMPL RANGE]. The characteristics of these two ranges are detailed in Table 1-13.

Table 1-13. Amplitude Range Characteristics

Characteristics	1 UI	10 UI
Maximum Jitter Amplitude	1.15 UI	11.5 UI
Frequency Range (INT Reference)	200 Hz to 3.5 MHz	200 Hz to 10 kHz
Frequency Range (EXT Reference)	2 Hz to 3.5 MHz	2 Hz to 10 kHz

Jitter Parameters

Before making jitter measurements the following Jitter parameters must be selected :-

Jitter Reference Clock

Jitter Filters

Jitter Threshold.

Jitter Reference Clock. The Jitter Reference Clock must be an unjittered, 139.264 MHz clock, and can be derived internally or provided from an External source to the rear panel JITT REF CLK I/P. To select the source of the Jitter Reference Clock :-

Press [JITTER PARAMETERS] to view the parameters in the parameters display.

Press [▶] or [◀] until REF is flashing on the top row of the parameters display.

The source selected (INT or EXT) will be flashing on the bottom row of the parameters display and can be changed using [▲] or [▼].

Jitter Filters. It is possible to connect filters in the jitter measurement path. The HP 3764A provides three filters, Low Pass 1 (3.5 MHz), High Pass 1 (200 Hz), High Pass 2 (10 kHz). To select the required combination of filters :-

Press [JITTER PARAMETERS] to view the parameters in the parameters display.

Press [▶] or [◀] until FLT is flashing on the top row of the parameters display.

The Filter selection will be flashing on the bottom row of the parameters display. Using [▲] or [▼] the user can select between :-

OFF (No Filters)

LP (Low Pass Only)

LP/HP1 (Low Pass & High Pass 1)

LP/HP2 (Low Pass & High Pass 2)

HP1 (High Pass 1 Only)

HP2 (High Pass 2 Only)

EXT(External Filters)

Selecting EXT allows the user to connect his own filters between the rear panel DEMOD JITT O/P and the JITT MEAS I/P and measure the demodulated jitter signal present at the rear panel DEMOD JITT O/P.

Jitter Threshold. The Jitter Threshold determines the level of measured Jitter which, if exceeded, will cause the HP 3764A to indicate a Jitter Hit has occurred. The Jitter Threshold range varies according to the Jitter Amplitude range selected :-

AMPL RANGE 1 UI 0.00 UI to 1.00 UI in 0.01 UI steps.

AMPL RANGE 10 UI 0.0 UI to 10.0 UI in 0.1 UI steps.

To select the Jitter Threshold :-

Press [JITTER PARAMETERS] to view the parameters in the parameters display.

Press [▶] or [◀] until THSH is flashing on the top row of the parameters display.

The Jitter Threshold can now be set using [▲], [▼], [▶] & [◀].

Jitter Gating

Before a Jitter measurement result can be obtained the gating must be set. The jitter gating is completely independent of the error measurement gating. Three types of gating are available :-

JITT MANUAL	Gating starts when [START/STOP] is pressed and stops when [START/STOP] is next pressed.
JITT SINGLE	Gating starts when [START/STOP] is pressed and stops when the user specified gating period ends or when [START/STOP] is next pressed.
JITT REP (Repetitive)	Gating starts when [START/STOP] is pressed. Each time the end of the user specified gating period is reached the gating automatically repeats. The gating stops when [START/STOP] is next pressed.

Manual Gating . Connect the jittered data or clock to be measured to the REC DATA INPUT or the REC CLOCK INPUT respectively.

The following procedure shows you how to make a JITTER HIT COUNT measurement with MANUAL gating :-

Press [JITT MEAS] until the JITTER HIT COUNT indicator is lit

Press [AMPL RANGE] until the 10 UI indicator is lit.

Press [JITTER PARAMETERS] then [▶] or [◀] until FLT is flashing in the upper row of the Parameters display.

Press [▲] until OFF is flashing in the bottom row of the Parameters display

Press [◀] then [▲] until INT is flashing in the bottom row of the Parameters display.

Press [◀] and using [▲], [▼], [◀] and [▶] set the Threshold to 1.00 UI.

Press [JITTER GATING PERIOD] to view the gating selection.

Press [▶] or [◀] and [▲] until JITT MANUAL is flashing in the Parameters display.

Press [START/STOP]

Note



1. The gating will continue until [START/STOP] is pressed.
 2. The JITTER HIT COUNT result will appear in the Results display and will increment by 1 each time the measured jitter exceeds 1 UI. The other Jitter measurement results can be displayed by pressing [JITT MEAS].
 3. The elapsed gating time can be displayed by pressing [VIEW TIME] and using [▶] or [◀] until T[▼] is flashing. The elapsed gating time is displayed in Days, Hours, Minutes, Seconds.
-

Single Gating. You will change the gating to SINGLE and set a gating period of 30 seconds :-

Press [START/STOP] to stop gating.

Press [▲] until JITT SINGLE is flashing in the Parameters display.

Press [▶] and set Days (flashing) to 00 using [▲] or [▼].

Press [▶] and set Hours (flashing) to 00 using [▲] or [▼].

Press [▶] and set Minutes (flashing) to 00 using [▲] or [▼]

Press [▶] and set Seconds (flashing) to 30 using [▲] or [▼]

Press [START/STOP]

Note



1. The gating will continue until the user selected gating period has elapsed. The gating will then stop until [START/STOP] is pressed. 2. The JITTER HIT COUNT result will appear in the Results display and will increment by 1 each time the measured jitter exceeds 1 UI. The other Jitter measurement results can be displayed by pressing [JITT MEAS]. 3. The elapsed gating time can be displayed by pressing [VIEW TIME] and using [▶] or [◀] until T^v is flashing. The elapsed gating time is displayed in Days, Hours, Minutes, Seconds.

Repetitive Gating. You will now select REPETITIVE gating, set gating period of 5 seconds and select CURRENT result :-

Press [▶] or [◀] and [▲] until JITT REP is flashing in the Parameters display.

Press [▶] (Days setting flashing 00).

Press [▶] (Hours setting flashing 00)

Press [▶] (Minutes setting flashing 00)

Press [▶] and set seconds to 05 using [▼]

Press [▶] & [▲] until CUR is flashing.

Press [START/STOP]

Note



1. PRV signifies that the result displayed will be from the previous Gating period. CUR signifies that the result displayed is from the current Gating Period. 2. At the end of each gating period a new gating period will begin. This will continue until [START/STOP] is pressed. 3. The JITTER HIT COUNT result will appear in the Results display and will increment by 1 each time the measured jitter exceeds 1 UI. The other Jitter measurement results can be displayed by pressing [JITT MEAS]. 4. The elapsed gating time can be displayed by pressing [VIEW TIME] and using [▶] or [◀] until T^v is flashing. The elapsed gating time is displayed in Days, Hours, Minutes, Seconds.

Measurement Preset & Keyboard Lock

The HP 3764A allows storage of nine complete front panel settings, Measurement Preset locations 1 to 9. Measurement Preset location 0 is pre-defined as Default Settings, and cannot be altered.

Measurement Preset Lock protects the stored settings within a Measurement Preset location. All 9 locations can be protected but each must be set individually.

Keyboard Lock disables the front panel keys preventing accidental disturbance of the measurement.

Keyboard Lock

To obtain Keyboard Lock :-

Press [SHIFT] then [LOCK PRESET]

All the front panel keys are now disabled with the exception of [SHIFT] [LOCK PRESET] and, if the Internal Printer is fitted, [PAPER FEED].

Note



If any other key is pressed the following message will appear in the Parameters display : NOT ALLOWED KYBRD LOCKED

To unlock the keyboard :-

Press [SHIFT] then [LOCK PRESET]

Measurement Preset Lock

Measurement Preset locations are selected using [RECALL] and the front panel settings stored using [SHIFT] then [RECALL]. New settings can only be stored if the Measurement Preset location is unlocked (LOCK indicator OFF).

Measurement Preset Lock is set using four decimal switches inside the HP 3764A front panel (on the A22 Assembly) to set up a combination (range 0000 to 9999). This combination must then be matched in the Parameters display to Lock or Unlock the Measurement Preset location :-

Remove the Power Cord from the HP 3764A

Remove the HP 3764A top cover and locate the 4 decimal switches on the A22 Assembly behind the Measurement Preset display.

Set the decimal switches to 2222 (Factory Preset to 0000)

Replace the top cover and re-connect power to the HP 3764A

When the switch on test routines are completed set the Measurement Preset Lock or Unlock :-

Press [RECALL] until 1 appears in the Preset display.

Press [LOCK PRESET] (Parameters display 0000 1st digit flashing)

Press [▲] until Parameters display shows 2000.

Press [▶] until 2nd digit is flashing.

Press [▲] until Parameters display shows 2200.

Press [▶] until 3rd digit is flashing.

Press [▲] until Parameters display shows 2220.

Press [▶] until 4th digit is flashing.

Press [▲] until Parameters display shows 2222 MATCHED.

In addition the bottom line of the Parameters display will be flashing either LOCKED or UNLOCKED. The Measurement Preset location can now be changed between LOCKED and UNLOCKED using [▲] or [▼]. The LOCK indicator will be ON when LOCKED is selected.

If LOCKED is selected the front panel settings stored in that location cannot be altered. The current front panel settings can be changed but if the location is vacated and then returned to at a later date the changes made will not have affected the stored settings.

Each Measurement Preset location must be separately LOCKED.

Note

The combination should be kept the same otherwise the user will need to remove power and reset the decimal switches each time.

Measurement Preset Store

To access Measurement Preset location 2 and store the front panel settings :-

Press [SHIFT] then [RECALL]

Press [▶] and [▲] or [▼] until PRESET 2 is flashing in the parameters display.

If necessary UNLOCK Preset location 2.

Select the front panel settings to be Stored.

Press [SHIFT] then [RECALL] to recover the Parameters display concerned with Store.

Press [▶] until STORE is flashing.

Press [▲] or [▼] to Store the front panel settings in Preset location 2.

If required the Measurement Preset location can be LOCKED by matching the combination set on the decimal switches.

Note

In Instruments with Serial No's below 2847U02888 the Store function was implemented differently.

Press [RECALL] until 2 appears in the Preset display.

If necessary UNLOCK Preset location 2.

Select the required front panel settings.

Press [SHIFT] then [RECALL] to store the front panel settings in non volatile memory.

Measurement Preset Recall

The settings stored in Measurement Preset locations 0 to 9 can be recalled by pressing [RECALL] until the required number appears in the Preset display :-

Press [RECALL] until 0 appears in the Preset display. (The front panel will now have Default Settings)

Press [RECALL] until 2 appears in the Preset display. (The front panel will now have those settings stored previously)

If required the Measurement Preset location can be LOCKED by matching the combination set on the decimal switches.

Flags

In the HP 3764A certain abnormal events which occur during a measurement generate a Flag. Only two flags can be displayed in the Flags display. If more than two flags are generated simultaneously, then the two most important are displayed in the Flags display. The order of importance of the flags is :-

1. UA Unavailable
2. DL Data Loss
3. CL Clock Loss
4. AI AIS
5. SL Sync Loss
6. OL Jitter Receiver Out of Lock (Opts 002, 007 Only)

The flags appear in the Flag display for the duration of the abnormal event. As soon as the event clears the flag disappears from the Flag display.

All flags detected by the HP 3764A are latched into non-volatile memory and can be viewed in the Parameter display by pressing [FLAGS VIEW]. Flags are only latched when the instrument is gating. When a new gating period is initiated the currently latched information is cleared.

All the flags latched to date can be viewed by pressing [FLAGS VIEW].

Each flag is displayed in the time order in which it first occurs, starting at the top left and finishing at the bottom right.

1st xx xx xx

xx xx xx Last

The flags viewed in the Parameters display can be cleared at any time by pressing [SHIFT] [FLAGS VIEW].

If a power failure occurs the current flag information is latched into non-volatile memory and restored at power on.

When Data Loss occurs the rear panel ERROR/HITS O/P will give a continuous stream of pulses.

When Sync Loss occurs the rear panel ERROR/HITS O/P will give output pulses equivalent to every other bit in error.

Auxiliary Inputs

The HP 3764A Auxiliary Input allows the logging of up to 8 external events; 7 Digital and 1 Analogue EG. *Loss Of Frame Alignment* as a digital event or *AGC Voltage of a Digital Microwave Radio* as an Analogue event.

The events to be logged should be connected to the rear panel AUX INPUTS connector.

These events can be selected, during Results configuration, to be output to an external printer via the HP-IB connector, output to the internal printer, or if a Tape Cartridge option is fitted (Opt 010), output to the Tape Cartridge Unit.

Table 1-14. Auxiliary Input Events

Use	Level	AUX Input Connection
Digital 1	ECL	Pin 6
Digital 2	ECL	Pin 7
Digital 3	ECL	Pin 8
Digital 4	TTL	Pin 1
Digital 5	TTL	Pin 2
Digital 6	TTL	Pin 3
Digital 7	TTL	Pin 4
Analog	-12.5 to +12.5 V	Pin 5
Ground		Pins 9 through 15

When selected during, Results Configuration, the state of the Auxiliary Inputs will be output under the following conditions :-

[START/STOP] is pressed to start or stop gating.

An Error/Hit Second occurs.

Any of the 7 Digital inputs changes state. (Input must remain active for a minimum of 70mS)

The Analogue Input passes through the threshold setting.

A Flag occurs (UA, DL, CL, AI, SL, OL)

[PRINT ON DEMAND] is pressed. (Internal Printer Only)

The Auxiliary Inputs state can be viewed and the Analogue Input threshold set in the Parameters display :-

Press [SHIFT] [VIEW TIME]

Press [▲] or [▼] until DIGITAL is flashing.

The state of the digital inputs appears in the Parameters display with Digital Input 1 on the right of the display and Digital Input 7 on the left of the display.

Press [▲] or [▼] until ANALOGUE is flashing.

The Analogue voltage is displayed on the top row of the Parameters display and the selected threshold on the bottom row.

Press [▶] or [◀] until the units digit of the threshold setting is flashing.

The threshold can now be set in the range -12.5 Volts to +12.5 Volts in 0.1V steps using [▶] [◀] [▲] [▼].

Setting Time & Date

The HP 3764A has an internal non-volatile real-time clock. The Time and Date can be displayed in the parameters display by pressing [VIEW TIME]. The display can be switched between Time (Hours, Minutes, Seconds) and Date (Day, Month, Year) by the Select keys [▶] & [◀]. The Time and Date can be set using [▶] [◀] [▲] & [▼] :-

TIME : Press [VIEW TIME] to display the Time & Date Headers.
Press [▶] or [◀] until the Time Header and the Hour (H) setting are flashing.
Press [▲] or [▼] to set the Hour in the range 0 - 23.
Press [▶] until the Minute (M) setting is flashing.
Press [▲] or [▼] to set the Minutes in the range 0 - 59.
Press [▶] until the Seconds (S) setting is flashing.

Note Pressing either [▲] or [▼] will set the Seconds to 00.



DATE : Press [▶] until the Date Header and the Day setting is flashing.
Press [▲] or [▼] to set the Day in the range 1 - 31.
Press [▶] until the Month setting is flashing.
Press [▲] or [▼] to set the Month in the range JAN - DEC.
Press [▶] until the Year setting is flashing.
Press [▲] or [▼] to set the Year.

Printer

When operated in the TALK ONLY mode the HP 3764A will output measurement results and messages to an external printer, in 80 column format, via the rear panel HP-IB connector.

The measurement results and messages can also be output to the internal printer in 20 column format. The measurement messages and their format are listed in Table 1-15.

Table 1-15. Printer Measurement Messages

Message	Notes
HH:MM:SS POWER LOSS DATE 15 JAN 1989	Printed at power on, but only if the instrument was gating and the peripheral was selected at the time of power failure.
HH:MM:SS: POWER UP DATE 15 JAN 1989	Printed at power on, but only if the instrument was gating and the peripheral was selected at the time of power failure.
HH:MM:SS 15 JAN 89 START SINGLE LNTH 00D 00H 00M 01S 139MB/s 2(23)-1 PRBS DATE 15 JAN 1989	At press of START key. At midnight if gating.
HH:MM:SS UNAVAIL	The system has become unavailable while gating.
HH:MM:SS AVAILABLE	The system has become available while gating.
HH:MM:SS DATA LOSS	The HP 3764A has lost data while gating.
HH:MM:SS DATA GAIN	The HP 3764A has regained data while gating.
HH:MM:SS CLOCK LOSS	The HP 3764A has lost clock while gating.
HH:MM:SS CLOCK GAIN	The HP 3764A has regained clock while gating.
HH:MM:SS SYNC LOSS	The HP 3764A has lost sync while gating.
HH:MM:SS SYNC GAIN	The HP 3764A has regained sync while gating.
HH:MM:SS AIS DETECT	The HP 3764A has detected AIS while gating.
HH:MM:SS AIS CLEAR	The HP 3764A AIS condition has cleared.
HH:MM:SS OUT LOCK	The jitter receiver has lost lock while gating (Internal Printer Opt 002 Only) (External Printer Opt 002, 007).
HH:MM:SS IN LOCK	The jitter receiver has regained lock while gating (Internal Printer Opt 002 Only) (External Printer Opt 002, 007).
HH:MM:SS (nnnnn)	An Error Second has occurred. Only printed if selected during Results Configuration. The number in parenthesis is the error count. (maybe n.nEnn)
HH:MM:SS EHS INHIBIT	Printed after 10 consecutive error second messages. Subsequent error second messages are suppressed until the next error-free second.

Table 1-15. Printer Measurement Messages (continued)

Message	Notes
HH:MM:SS EHS RELEASE	Printed at the first error-free second after a period of suppression of error second messages.
HH:MM:SS END PERIOD	Printed at the end of a SINGLE or REP gating period and followed by the selected results.
HH:MM:SS STOP	Printed when STOP key is pressed and followed by the selected results.
HH:MM:SS PRINT DMND	Printed when PRINT ON DEMAND key is pressed and followed by the selected results.(Internal Printer only)
HH:MM:SS DG 100U1D1 HH:MM:SS ANLG 4.7V	Printed if the AUXILIARY INPUT results are selected during Results Configuration. Analogue Input value is in Volts. The seven digital inputs are represented by :- 1 = this input remains high 0 = this input remains low U = this input has just gone high D = this input has just gone low
LOCKED PANEL n USED	At press of START key, if a locked MEASUREMENT PRESET location has been recalled and no configuration changes are made to the front panel settings before the START key is pressed.

Connecting The External Printer

Configure an HP Thinkjet printer to LISTEN ALWAYS :-

Switch OFF the power to the HP Thinkjet printer.

Set position 2 of the printer HP-IB configuration switch to "1" (Listen Always). All other switch positions are irrelevant in this configuration.

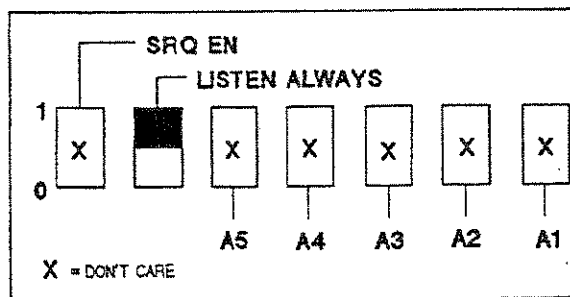

Figure 1-3. Thinkjet HP-IB Configuration Switch

Connect the HP Thinkjet printer to the HP 3764A rear panel HP-IB connector.

Configuring Results (External Printer)

The HP 3764A must be configured to TALK ONLY to output results to the External printer. The results are configured using [SHIFT] [LOCAL] to display the choice of result formats in the Parameter display. The required format is selected using [▶] [◀] [▲] [▼].

All 8 of the Error & Error Performance measurement results are output to the external printer at the end of the gating period. Error/Hit Second (EHS) messages are selectable as are the AUXILIARY INPUT results.

Note



If a Jitter Option is fitted (Opts 002, 007) and a Jitter measurement is selected then all 4 Jitter measurement results are output to the external printer at the end of the gating period in place of the Error & Error Performance measurement results.

To select TALK ONLY and configure the results :-

Press [SHIFT] [LOCAL] (MODE or FMT will be flashing)

Press [▶] or [◀] until MODE is flashing.

Press [▲] or [▼] until MODE & TALK ONLY are flashing.

Press [▶] until FMT is flashing.

The parameter in the bottom left position of the Parameter display will also be flashing. This will be in the form of ALW or C>0 or R>N. These choices can be made using [▲] or [▼] and their meaning is :-

- ALW: All 8 Error & Error Performance measurement results, (ERROR RATIO, ERROR COUNT, ERROR SEC, ERROR FREE SEC, % UNAVAIL, %SES, %DM, %ES) are output at the end of the gating period.
- C>0: All 8 Error & Error Performance measurement results are output at the end of the gating period, if the data Error Count is greater than zero.
- R>N: All 8 Error & Error Performance measurement results are output at the end of the gating period, if the Error Ratio is worse than or equal to 1×10^{-N} . The parameter N is selectable in the range 1 to 15 using [▲] or [▼].
-

Note



If a Jitter option is fitted (Opts 002, 007) and a Jitter measurement is selected the selections available are :-

ALW: All 4 Jitter measurement results (PK_PK MAX, HIT COUNT, HIT SEC, HIT FREE SEC) are output at the end of the gating period.

C>0: All 4 Jitter measurements are output at the end of the gating period, if the Jitter Hit Count is greater than 0.

R>N: The same as C>0 IE. All 4 Jitter measurements are output at the end of the gating period, if the Jitter Hit Count is greater than 0. (The Error Ratio function of R>N is not valid when making Jitter Measurements).

Press [▲] or [▼] until ALW is flashing.

Press [▶]

The parameter in the centre bottom position of the Parameter display will be flashing. This will take the form of EHS or OFF. These choices can be made using [▲] or [▼] and their meaning is :-

- EHS :** Error/Hit Second messages will be output during the gating period. This message will include the number of Errors/Hits which have occurred in the Error Second.
If 10 consecutive Error/Hit Seconds occur a EHS INHIBIT message is output and no further Error/Hit Second messages will be output until an Error/Hit Free Second occurs. This prevents waste of printer paper when making unattended measurements under serious failure conditions.
After the sequence of 10 or more Error/Hit Seconds followed by an Error/Hit Free Second the EHS RELEASE message will be output and subsequent Error Seconds will be output as before.
- OFF :** Error/Hit Second messages are disabled.

Note  If an Error measurement is selected then Error Seconds will cause the EHS message to be output.

If a Jitter Option (Opts 002, 007) is fitted and a Jitter measurement is selected then Hit Seconds will cause the EHS message to be output.

Press [▲] or [▼] until EHS is flashing

Press [▶]

The parameter in the bottom right position of the Parameters display will also be flashing. This will be in the form of AUX or OFF. These choices can be made using [▲] or [▼] and their meaning is :-

- AUX :** the state of the rear panel AUXILIARY INPUTS are included in the results output to the printer.
- OFF :** the state of the AUXILIARY INPUTS are not included in the results output to the printer.

Press [▲] or [▼] until OFF is flashing.

The HP 3764A results format is now selected to be ALW EHS OFF

Note  The results can be configured differently for each of the 10 MEASUREMENT PRESET locations. The Mode (Talk Only/ Addressable) is common to all 10 locations.

Printing Results

To obtain the printout shown below, the HP 3764A was configured to TALK ONLY and an HP Thinkjet printer was connected to the HP 3764A rear panel HP-IB connector. The HP 3764A was connected back to back and set to make Error measurements on a 139.264 Mbit/s, PRBS, CMI coded data stream during a Repetitive gating period of 30 Seconds. The results were configured to ALW EHS OFF.

Action	Printed Result/Message
Press [START/STOP]	The START message appears on the printer.
Press [ERROR ADD SINGLE]	Each time [ERROR ADD SINGLE] is pressed an Error/Hit Second (EHS) message appears on the printer. At the end of the measurement gating period (30 Seconds) the END PERIOD message, which includes the selected measurement results, appears on the printer.
Press [START/STOP]	The STOP message, which includes the measurement results, appears on the printer.

There are many other messages which can be logged on the external printer and these are detailed in Table 1-15.

```

Link Identification :
Generator Location :
Receiver Location :
Gating Period      : REPETITIVE   LENGTH: 000 00H 00M 30S
Start              : 22:16:17    16 FEB 84
RATE               : 139 Mb/s
PATTERN            : 01010101 WRD
                   : 01010101

```

TIME	UNAVAIL SECONDS	SEVERELY ERRORED SECONDS	DEGRADED MINUTES	ERRORED SECONDS	BIT ERROR RATIO	ERROR COUNT	ERROR SECONDS	ERROR FREE SECONDS
22:16:30		ERROR SECOND: NUMBER OF ERRORS (1.1E05)						
22:16:32		ERROR SECOND: NUMBER OF ERRORS (95570)						
22:16:34		ERROR SECOND: NUMBER OF ERRORS (95755)						
22:16:37		ERROR SECOND: NUMBER OF ERRORS (63765)						
22:16:38		ERROR SECOND: NUMBER OF ERRORS (14582)						
22:16:47		END PERIOD						
22:16:47	0.000%	16.67%	NO RSLT	16.67%	9.2E-05	3.9E05	5	25
22:16:51		STOP LENGTH OF GATING PERIOD: 000 00H 00M 04S						
22:16:51	0.000%	0.000%	NO RSLT	0.000%	0	0	0	4

Figure 1-4. Thinkjet Printout Of Measurement Results & Messages

Internal Printer

When an internal printer is fitted, measurement results and messages can be routed to the printer. The measurement results and messages are the same as those output to an external printer except that the internal printer format is 20 column.

Note Options 007 & 010 exclude an Internal Printer



Configuring Results (Internal Printer)

The results are configured using [SHIFT] [PAPER FEED] to display the choice of result formats in the Parameter display. The required format is selected using [▶] [◀] [▲] [▼].

When configuring the results the user is allowed to choose which of the Error & Error Performance measurement results are routed to the internal printer at the end of the gating period. Any or all of the 8 Error & Error Performance measurement results can be chosen.

If Option 002 is fitted and a Jitter measurement is selected the user is allowed to choose which of the Jitter measurement results are routed to the internal printer at the end of the gating period. Any or all of the 4 Jitter measurement results can be chosen.

Error/Hit Second (EHS) messages are selectable as are the AUXILIARY INPUT results.

To configure the results to the internal printer :-

Press [SHIFT] [PAPER FEED] (FMT or RESULT will be flashing).

Press [▶] or [◀] until FMT is flashing.

The parameter in the bottom left position of the Parameter display will also be flashing. This will be in the form of ALW or C>0 or R>N. These choices can be made using [▲] or [▼] and their meaning is :-

- ALW: The selected Error & Error Performance measurement results (1 or more of ERROR RATIO, ERROR COUNT, ERROR SEC, ERROR FREE SEC, %UNAVAIL, %SES, %DM, %ES) are output at the end of the gating period.
- C>0: The selected Error & Error Performance measurement results are output at the end of the gating period, if the data Error Count is greater than zero.
- R>N: The selected Error & Error Performance measurement results are output at the end of the gating period, if the Error Ratio is worse than or equal to 1×10^{-N} . The parameter N is selectable in the range 1 to 15 using [▲] or [▼].

Note If Option 002 is fitted and a Jitter measurement is selected the selections available are :-



ALW: The selected Jitter measurement results (1 or more of PK.PK MAX, HIT COUNT, HIT SEC, HIT FREE SEC) are output at the end of the gating period.

C>0: The selected Jitter measurements are output at the end of the gating period, if the Jitter Hit Count is greater than 0.

R>N: The same as C>0 IE. The selected Jitter measurements are output at the end of the gating period, if the Jitter Hit Count is greater than 0. (The Error Ratio function of R>N is not valid when making Jitter Measurements).

Press [▲] or [▼] until ALW is flashing.

Press [▶]

The parameter in the centre bottom position of the Parameter display will be flashing. This will take the form of EHS or OFF. The two choices can be made using [▲] or [▼] and their meaning is :-

EHS : Error/Hit Second messages will be output during the gating period This message will include the number of Errors/Hits which have occurred in the Error/Hit Second.

If 10 consecutive Error/Hit Seconds occur a EHS INHIBIT message is output and no further Error/Hit Second messages will be output until an Error/Hit Free Second occurs. This prevents waste of Printer Paper when making unattended measurements under serious failure conditions.

After the sequence of 10 or more Error/Hit Seconds followed by an Error/Hit Free Second the EHS RELEASE message will be output and subsequent Error/Hit Seconds will be output as before.

OFF : Error/Hit Second messages are disabled.

Note



If an Error measurement is selected then Error Seconds will cause the EHS message to be output.

If Option 002 is fitted and a Jitter measurement is selected then Hit Seconds will cause the EHS message to be output.

Press [▲] or [▼] until EHS is flashing

Press [▶]

The parameter in the bottom right position of the Parameters display will also be flashing. This will be in the form of AUX or OFF. These choices can be made using [▲] or [▼] and their meaning is :-

AUX : the state of the rear panel AUXILIARY INPUTS are included in the results output to the printer.

OFF : the state of the AUXILIARY INPUTS are not included in the results output to the printer.

Press [▲] or [▼] until OFF is flashing.

Press [▶] until RESULT is flashing.

The bottom row of the Parameter display will be EPxxxx Exxxx (x = Y or N) if an Error or Error Performance measurement is selected

Note

If Option 002 is fitted and a Jitter measurement is selected the bottom row of the Parameter display will be JMxxxx (x = Y or N).

One of the N's or Y's will be flashing and the display meaning is :-

- EP :** Error Performance measurements. Each N or Y represents one of the 4 measurements as follows :- EP %UNAVAIL, %SES, %DM, %ES.
- N signifies Result Not Printed. Y signifies Result Printed. The selection of Y or N can be made using [▲] or [▼].
- E :** Error measurements. Each N or Y represents one of the 4 measurements as follows :- E ERROR RATIO, ERROR COUNT, ERROR SEC, ERROR FREE SEC.
- N signifies Result Not Printed. Y signifies Result Printed. The selection of Y or N can be made using [▲] or [▼].
- JM :** Jitter measurement (Opt 002 Only). Each N or Y represents one of the 4 measurements as follows :- JM PK_PK MAX, HIT COUNT, HIT SEC, HIT FREE SEC.
- N signifies Result Not Printed. Y signifies Result Printed. The selection of Y or N can be made using [▲] or [▼].

Note

If all the measurement results are set to N (Not Printed) then only the result of the Measurement currently selected on the Front Panel is routed to the internal printer.

The results can be configured differently for each of the 10 MEASUREMENT PRESET locations.

Printing Results

Pressing [PAPER FEED] will cause the printer paper to unroll. If the key is held down continuous paper feeding will occur.

A printout of the results can be obtained at any time if PRINT ON DEMAND is selected :-

Press [SHIFT] then [PRINT]

The selected measurement results and the Time will be printed whether or not the HP 3764A is gating.

Note

The measurement messages listed in Table 1-15 will not be printed when PRINT ON DEMAND is selected.

The measurement messages listed in Table 1-15 will be printed as will the measurement results if [PRINT] is pressed and a measurement started.

To obtain the printout shown below the HP 3764A was connected back to back and set to make Error measurements on a 139.264 Mbit/s, PRBS, CMI coded data stream during a

Repetitive gating period of 30 Seconds. The results were configured to ALW EHS OFF and the results to be printed selected as EPYYNY EYYYY.

Action	Printed Result/Message
Press [PRINT] then [START/STOP]	As [PRINT] was pressed before the measurement gating period was started the START message appears on the printer.
Press [ERROR ADD SINGLE]	Each time [ERROR ADD SINGLE] is pressed an Error/Hit Second (EHS) message appears on the printer. At the end of the measurement gating period (30 Seconds) the END PERIOD message, which includes the selected measurement results, appears on the printer.
Press [START/STOP]	The STOP message, which includes the measurement results, appears on the printer.

There are many other messages which can be logged on the internal printer and these are detailed in Table 1-15.

```
14:53:15 30 JAN 89
START    REPETITIVE
LNTH 000 00H 00M 30S
139MB/s 01010101 WRD
01010101
```

```
14:53:18 ESC      1)
14:53:19 ESC      1)
14:53:22 ESC      1)
14:53:24 ESC      1)
14:53:28 ESC      1)
14:53:30 ESC      1)
14:53:36 ESC      1)
14:53:45 END PERIOD
UNAVAIL SECS 0.000%
SEV ERR SECS 0.000%
ERRORED SECS 23.33%
ERROR RATIO 2 E-09
ERROR COUNT 7
ERROR SECS 7
ERR FREE SEC 23
```

```
14:53:52 STOP
LNTH 000 00H 00M 07S
UNAVAIL SECS 0.000%
SEV ERR SECS 0.000%
ERRORED SECS 0.000%
ERROR RATIO 0
ERROR COUNT 0
ERROR SECS 0
ERR FREE SEC 7
```

Figure 1-5. Internal Printer Measurement Results & Messages

Paper Roll Replacement (Internal Printer)

To replace the paper roll (Part Number 9270-1151) in the HP 3764A Internal Printer proceed as follows :-

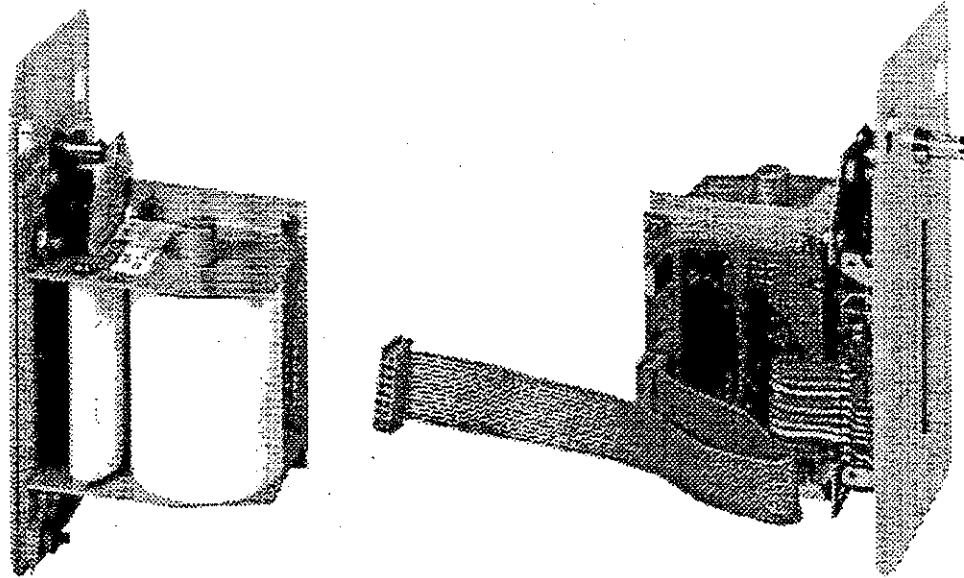

Figure 1-6. Paper Roll & Ribbon Cable

1. Switch off the 3764A and remove the Line Input cable.
2. Unscrew the knurled screw at the top of the printer assembly front panel and withdraw the complete assembly.
3. Disconnect the ribbon cable (note position of cable connection) from the printed circuit (p.c.) board.
4. Unscrew the knurled screw securing paper roll retaining spindle.
5. Remove spindle and spent paper roll.
6. Locate unused paper roll between mounting brackets and insert spindle through brackets and roll core. Outer end of paper should be nearest p.c. board facing towards the printer assembly front panel.
7. Secure spindle to brackets by means of knurled screw.
8. Ensure end of paper is cut cleanly and square, or in leading "V" shape.
9. Pass end of paper over guide bar and into printer mechanism loading slot see Figure 1-6.
10. Push paper into slot until resistance is felt.
11. Re-connect the ribbon cable to the p.c. assembly.

Caution



Ensure the ribbon cable is connected correctly as shown in Figure 1-3. If the ribbon cable is connected incorrectly **NOT ALLOWED NO OPTION FITTED** will appear in the Parameters display when the printer is asked to Print or Feed Paper.

Replace the printer assembly in the HP 3764A and tighten the knurled screw. Re-connect the Line Input cable and switch-on the HP 3764A.

Press the PAPER FEED key until paper emerges from the front panel slot.

Ribbon Replacement (Internal Printer)

To replace the printer ribbon (Part Number 9282-1005) proceed as follows :-

Remove the internal Printer from the HP 3764A by unscrewing the knurled screw on the Printer front panel and carefully withdrawing the complete assembly.

Disconnect the ribbon cable from the p.c. board (Note how the cable is connected).

Undo the two 6-32 nuts which secure the Printer Unit to its front panel and remove the printer unit.

The ribbon cartridge can now be lifted away from the Printer and replaced.

Re-assembly is a reversal of the above procedure.

Note



Take great care not to overtighten the two 6-32 nuts holding the Printer Unit to the Printer assembly front panel. Also ensure that the ribbon cable is connected correctly (see Figure 1-3). If the ribbon cable is incorrectly fitted the HP 3764A PARAMETER display will indicate **NOT ALLOWED NO OPTION FITTED** when the printer is next asked to print or feed paper.

Tape Cartridge Unit (Opt 010)

The Tape Cartridge Unit provides the capability for local mass storage of data. The capacity of each tape cartridge is 217,600 bytes, where each byte is one alphanumeric character. The Tape Cartridge can be used for Data recording EG. measurement results & messages or recording of front panel Settings.

Tape Initialization

The Tape must be initialized before any Data or Settings can be recorded. Two types of initialization are provided IE. Data & Settings. If Data initialization is selected the Tape can not be used to store front panel Settings. If Settings initialization is selected the Tape cannot be used to store Measurement Results.

Data Initialize

Data Initialization sets up a directory at the beginning of the tape and creates one large data file, of 217,600 bytes, called DATA. The Initialization process also pre-marks 850 Records of 256 bytes each.

Data Initialization is selected by pressing [INIT] and takes approximately 6 minutes to complete.

The Initialization process can also be carried out with the tape inserted in an HP 85 Personal Computer and issuing the following commands :-

```
ERASETAPE  
CREATE "DATA", 850
```

Settings Initialize

Settings Initialization sets up a directory at the beginning of the tape and creates a small data file, called SETTING. The Initialization process also pre-marks 10 Records of 256 bytes each.

Settings Initialization is selected by pressing [SHIFT] [INIT] and takes approximately 20 seconds to complete.

The Initialization process can also be carried out with the tape cartridge inserted in an HP 85 Personal Computer and issuing the following commands :-

```
ERASETAPE  
CREATE "SETTING",10
```

Tape Cartridge Measurement Messages

The tape cartridge, when Initialized for DATA, can be used to Store measurement results and the measurement messages listed in Table 1-16.

Note

Option 007 excludes a Tape Cartridge Unit



Table 1-16. Tape Cartridge Measurement Messages

Message	Notes
HH:MM:SS POWER LOSS DATE 15 JAN 1989	Recorded at power on, but only if the instrument was gating and the Tape Cartridge was selected at the time of power failure.
HH:MM:SS: POWER UP DATE 15 JAN 1989	Recorded at power on, but only if the instrument was gating and the Tape Cartridge Unit was selected at the time of power failure.
HH:MM:SS 15 JAN 89 START SINGLE LNTH 00D 00H 00M 01S 139MB/s 2(23)-1 PRBS DATE 15 JAN 1989	At press of START key. At midnight if gating.
HH:MM:SS UNAVAIL	The system has become unavailable while gating.
HH:MM:SS AVAILABLE	The system has become available while gating.
HH:MM:SS DATA LOSS	The HP 3764A has lost data while gating.
HH:MM:SS DATA GAIN	The HP 3764A has regained data while gating.
HH:MM:SS CLOCK LOSS	The HP 3764A has lost clock while gating.
HH:MM:SS CLOCK GAIN	The HP 3764A has regained clock while gating.
HH:MM:SS SYNC LOSS	The HP 3764A has lost sync while gating.
HH:MM:SS SYNC GAIN	The HP 3764A has regained sync while gating.
HH:MM:SS AIS DETECT	The HP 3764A has detected AIS while gating.
HH:MM:SS AIS CLEAR	The HP 3764A AIS condition has cleared.
HH:MM:SS OUT LOCK	The jitter receiver has lost lock while gating (Opt 002 Only)
HH:MM:SS IN LOCK	The jitter receiver has regained lock while gating (Opt 002 Only)
HH:MM:SS (nnnnn)	An Error/Hit Second has occurred. Recorded only if selected during Results Configuration. The number in parenthesis is the Error/Hit Count. (maybe n.nEnn)
HH:MM:SS EHS INHIBIT	Recorded after 10 consecutive Error/ Hit Second messages. Subsequent Error/Hit Second messages are suppressed until the next Error/Hit Free Second.
HH:MM:SS EHS RELEASE	Recorded at the first Error/Hit Free Second after a period of suppression of Error/Hit Second messages.
HH:MM:SS END PERIOD	Recorded at the end of a SINGLE or REP gating period and followed by the selected results.

Table 1-16. Tape Cartridge Measurement Messages (continued)

Message	Notes
HH:MM:SS STOP	Recorded when STOP key is pressed and followed by the selected results.
HH:MM:SS DG 100U1D1	Recorded if the AUXILIARY INPUT results are selected during Results Configuration. Analogue Input value is in Volts. The seven digital inputs are represented by :- 1 = this input remains high 0 = this input remains low U = this input has just gone high D = this input has just gone low
HH:MM:SS ANLG 4.7V	
LOCKED PANEL n USED	Recorded at press of START key, if a locked MEASUREMENT PRESET location has been recalled and no configuration changes are made to the front panel settings before the START key is pressed.

Configuring Results

The measurement results to be stored on the tape cartridge are configured using the Tape Cartridge Unit [CONFIG] key to display the choice of result formats in the Parameters display. The required format is selected using [▶] [◀] [▲] [▼].

All 8 of the Error & Error Performance measurement results will be stored on the tape cartridge, at the end of the gating period, if [STORE] is selected on the Tape Cartridge Unit.

Note



If Option 002 is fitted and a Jitter measurement is selected all 4 of the Jitter measurement results are stored on the tape cartridge, at the end of the gating period, if [STORE] is selected on the Tape Cartridge Unit.

Error/Hit Second (EHS) messages are selectable as are the AUXILIARY INPUT results.

To configure the results to the Tape cartridge :-

Press [CONFIG]

The parameter in the bottom left position of the Parameter display will be flashing. This will be in the form of ALW or C>0 or R>N. These choices can be made using [▲] or [▼] and their meaning is :-

- ALW: All 8 of the Error & Error Performance measurement results (ERROR RATIO, ERROR COUNT, ERROR SEC, ERROR FREE SEC, %UNAVAIL, %SES, %DM, %ES) are stored at the end of the gating period.
- C>0: All 8 of the Error & Error Performance measurement results are stored, at the end of the gating period, if the data Error Count is greater than zero.
- R>N: All 8 of the Error & Error Performance measurement results are stored, at the end of the gating period, if the Error Ratio is worse than or equal to 1×10^{-N} . The parameter N is selectable in the range 1 to 15 using [▲] or [▼].

Note

If Option 002 is fitted and a Jitter measurement is selected the selections available are :-

ALW: All 4 of the Jitter measurement results (PK_PK MAX, HIT COUNT, HIT SEC, HIT FREE SEC) are stored at the end of the gating period.

C>0: All 4 of the Jitter measurement results are stored, at the end of the gating period, if the Jitter Hit Count is greater than 0.

R>N: The same as C>0 IE. All 4 of the Jitter measurement results are stored, at the end of the gating period, if the Jitter Hit Count is greater than 0. (The Error Ratio function of R>N is not valid when making Jitter measurements).

Data Storage

If necessary Initialize the Tape cartridge for DATA :-

Insert the Tape cartridge such that its label is to the right and its open edge is toward the HP 3764A. The Tape Cartridge Unit drive door opens when the Tape cartridge is pressed against it and the Tape cartridge can be pushed home.

Press [INIT]

Note

Initialization will take approximately 6 minutes to complete, signified by the INIT and TAPE indicators changing to the OFF condition.

When DATA initialization is complete :-

Press Tape Cartridge Unit [STORE]. (Primes the Tape Cartridge Unit for Data recording of Measurement results & messages).

Configure the HP 3764A to make the required measurement and start gating.

The Results Configuration set previously to ALW EHS OFF will provide the following results & messages :-

When the gating is started the START message is stored on the tape cartridge.

Occurrences of Error Seconds will be stored on the Tape cartridge during the gating period.

At the end of the Gating period the measurement results will be stored on the Tape cartridge.

When the gating is stopped the STOP message, which includes measurement results, is stored on the tape cartridge.

There are many other messages which can be recorded on the tape cartridge and these are detailed in Table 1-16.

The tape cartridge has two tracks and a capacity of 217,600 bytes where each byte is one alphanumeric character. When one track is full the tape is automatically rewound before recording on track 2. The tape rewind action takes approximately 28 seconds and during this time recording is not possible. Data to be recorded is not lost but held in internal buffers until the rewind is complete.

When the tape cartridge is completely full the **TAPE FULL** message is displayed in the Parameters display and an audible *beep* occurs. A new tape cartridge, which has been Initialized for DATA, can be inserted and recording continued :-

Press [STORE] (The STORE indicator will go OFF)

Replace the old tape cartridge with the new DATA Initialized tape cartridge.

Press [STORE] (Data recording will now continue)

Note

1. The Data to be stored on the tape cartridge is held in an internal buffer (capacity 253 bytes). The Data is transferred to the tape cartridge when the buffer is full i.e. 253 bytes at a time. At the end of a sequence of measurements, it is very likely the buffer will contain some Data. It is important that this Data is transferred to the tape cartridge before the tape cartridge is removed. Pressing [STORE], before removing the tape cartridge, results in the Data in the buffer being padded out, with spaces, to 253 bytes. The 253 bytes are then transferred to the tape cartridge.
2. After pressing [STORE], before removing the tape cartridge, wait a few seconds for the **TAPE CARTRIDGE UNIT** indicator to go OFF. (The indicator is situated immediately above the Tape Cartridge Unit drive door). This signifies that the last 253 bytes have been transferred.

Caution

1. The tape cartridge should never be removed when the **TAPE CARTRIDGE UNIT** indicator is lit as corruption of Data or damage to the tape may occur.
2. If **TAPE VERIFY** error messages frequently appear in the Parameters display these must not be ignored. Steps should be taken to prevent loss of Data stored on the tape cartridge :-
 1. Clean the tape cartridge
 2. Re-Initialize the tape Cartridge
 3. If either of the above fail to cure the problem, retire the tape cartridge as continued use will only lead to loss of Data or damage to the tape drive.
3. If **TAPE MOTOR STALL** error messages appear in the Parameters display these must not be ignored as continued use will only lead to loss of Data or damage to the Tape Cartridge Unit drive. To determine the source of the problem, try a different tape cartridge. If the error messages cease to appear retire the original tape cartridge. If the error messages continue, the Tape Cartridge Unit drive may require servicing.

In the event of a power down the contents of the 253 byte internal buffer will be transferred to the non volatile memory and transferred to the tape cartridge when power is restored. If the instrument is powered up with a tape cartridge in place and the STORE indicator lit, Data recordings will continue at the point on the tape where it left off when powered down. If however a different tape cartridge is inserted while the instrument is powered down, this will not be detected and Data recording will almost certainly start at the wrong place.

Settings Storage

The tape cartridge, when Initialized for SETTINGS, can be used to store the contents of Measurement Preset locations 1 to 9. The Measurement Preset LOCK combination, for each location, is also stored.

To Store the Measurement Preset locations :-

Press [SHIFT] [STORE]

Recall Stored Data

Data is Recalled by pressing [RECALL]. The Data stored on the tape cartridge will be read from the tape cartridge and output to a peripheral device connected to the rear panel HP-IB connector. The normal peripheral device is an HP 85 Calculator. The Data can be accessed in the HP 85 using a program such as :-

```
10 DIM A$(253)
```

```
20 ASSIGN #1 to "DATA"
```

```
30 READ #1;A$
```

Each time line 30 is executed a 253 byte record is read from the tape cartridge. These 253 bytes (characters) of Data will need to be segmented into 80 character messages i.e. the original HP 3764A output format.

Note



Those tape cartridge records which were stored as a result of de-selecting [STORE] may contain as many as 252 spaces.

The [RECALL] function is disabled when Gating is in progress.

Recall Stored Settings

Settings are Recalled by pressing [SHIFT] [RECALL]. The Settings stored on the tape cartridge will overwrite the contents of Measurement Preset locations 1 to 9, even if the location is LOCKED. The current front panel settings will remain unaltered.

Note



The [SHIFT] [RECALL] function is disabled if gating is in progress.

The [SHIFT] [RECALL] function is disabled if the Settings recorded on the tape cartridge were recorded from an instrument with a different option mix or from an instrument with a different front panel settings structure.

General Information

The tape cartridge used with the HP 3764A is a high quality digital storage medium which requires care and maintenance during use.

Inserting/Removing Tape Cartridge

Insert the tape cartridge such that its label is to the right, and its open edge is toward the HP 3764A. The Tape Cartridge Unit drive door opens when the tape cartridge is pressed against it. The tape cartridge can then be pushed home.

The tape cartridge can be removed by pressing the bar to the left of the Tape Cartridge Unit drive. The Tape Cartridge Unit drive will disengage the tape cartridge such that it can be removed freely.

Write Protection

Once Data has been stored on a tape cartridge you can prevent the Data being overwritten by sliding the RECORD slide tab to the left before inserting the tape cartridge and carrying out a [RECALL] function. If you subsequently wish to record Data on the tape cartridge the RECORD tab must be set all the way to the right.

Tape Care

The Tape Cartridge Unit drive will become dirty after extensive use. Dirty Tape Cartridge Unit drives are one of the most common causes of Data error or loss. The following precautions should reduce the risk of such problems :-

Clean the Tape Cartridge Unit head and the Tape Cartridge Unit drive capstan after every 8 hours of cumulative use, or more frequently if the operating environment is dirty. Dampen a cotton tipped swab with isopropyl alcohol. Wipe the Tape Cartridge Unit head and capstan with the swab, backwards and forwards, in the direction of Tape motion.

After cleaning the Tape Cartridge Unit head wipe it clean of any solution residue using a dry cotton swab. Wipe backward and forwards in the direction of tape motion.

When not using the HP 3764A Tape Cartridge Unit remove the tape cartridge from the Tape Cartridge Unit drive. If a tape cartridge is left in place, a flat spot may develop on the rubber wheel of the Tape Cartridge Unit drive capstan. This will cause errors when using the tape cartridge. If a flat spot occurs it can be corrected by "conditioning" the tape cartridge.

Conditioning entails, running the tape cartridge until the end of the tape is reached, reversing it, and running it backwards until the beginning of the tape. It is good practice to condition the tape cartridge after every 6 to 8 hours of use. Conditioning is done by inserting the tape cartridge in an HP 85 Calculator and Executing the CTAPE command.

Note



1. The Tape Cartridge Unit head is the shiny surface on the lower rear of the Tape Cartridge Unit drive.
 2. It is GOOD practise to clean the Tape Cartridge Unit head prior to making an important recording.
-

Tape Life

A tape cartridge has a typical life span of 50 to 100 hours of cumulative use. Because tape cartridges wear out it is advisable to maintain back up copies of vital Data and Settings.

When the tape cartridge has reached the end of its useful life it will exhibit one or more of these danger signals :-

The oxide starts breaking loose from the mylar backing of the magnetic tape.

The Tape Cartridge Unit drive belt becomes loose, indicated by the tape winding unevenly on the tape reels. This can be viewed through the top of the tape cartridge. Slight unevenness is common; you should be concerned when the tape is uneven by as much as a 1/4 the width of the tape.

The drive pulley of tape cartridge exhibits "dark spots" due to slippage. In severe cases the tape cartridge may stall and the capstan will wear a flat spot on the drive pulley.

The tape cartridge rattles rather than making a constant hum when the tape is in motion.

TAPE VERIFY or **TAPE MOTOR STALL** error messages appear in the Parameters display.

If any of these danger signals occur the tape cartridge should be replaced immediately. Continuing to use a tape cartridge under these conditions will lead to loss of Data or damage to the Tape Cartridge Unit drive.

Making Measurements

This section explains the measurement capabilities of the HP 3764A, and demonstrates the HP 3764A's ability to perform the measurements required when :-

- developing and testing new equipment
- routine testing of the transmission network
- troubleshooting on a transmission line.

KEY MEASUREMENT PARAMETERS

Gating Period (Measurement Interval)

Synchronization

ERROR & ERROR PERFORMANCE MEASUREMENTS

Error Measurement Menu

Error Performance Measurement Menu

Clock Recovery Tolerance Measurement

565 Mbit/s Fibre Optic Measurement

JITTER MEASUREMENTS

Jitter Measurement Menu

Basic Jitter Measurements

Jitter Tolerance Measurement

Jitter Transfer Measurement

De-Multiplexer Jitter Measurement

Key Measurement Parameters

When making measurements with the HP 3764A the Gating Period (Measurement Interval) and type of Synchronization chosen are of some importance.

Gating Period (Measurement Interval)

The time interval during which the measurement is made is known as the Gating Period. Three types of Gating are available with the HP 3764A :-

MANUAL	Gating starts when [START/STOP] is pressed and stops when [START/STOP] is next pressed.
SINGLE	Gating starts when [START/STOP] is pressed and stops when the user specified gating period ends or when [START/STOP] is next pressed.
REPETITIVE	Gating starts when [START/STOP] is pressed. Each time the end of the user specified gating period is reached the gating automatically repeats. The gating stops when [START/STOP] is next pressed.

Note



If SINGLE or REPETITIVE is selected the user must specify the Period length in the range 1 Second to 99 Days.

When REPETITIVE is selected a choice is available between the displayed result being updated throughout the gating period IE Current (CUR) gating period, or the displayed result only being updated at the end of the gating period IE Previous (PRV) gating Period.

If a Jitter option (002 or 007) is fitted the Jitter gating period is independent of the Error gating period but all the same parameters apply.

Synchronization

When making measurements it is necessary for the HP 3764A internally generated Receiver pattern and the generated pattern to be in Synchronization. Three methods of Synchronization are available :-

Automatic (AUTO) AUTO Sync is selected by pressing [SYNC] until the AUTO indicator is lit. The instrument will carry out Sync Searches until Synchronization (Sync Gain) is achieved.

When Sync Gain has been achieved (<10 Errors in 90 Clocks) the instrument will monitor the received data for Sync Loss (>10,000 Errors in 90,000 Clocks).

When Sync Loss is detected, the instrument will, halt the measurement in progress, clear the measurement counters, initiate a Sync Search, and indicate Sync Loss by means of a FLAG (SL) in the Flags Display. Sync Search will be repeated if necessary until Sync Gain is achieved.

External (EXT)

EXT Sync is selected by pressing [SYNC] until the EXT indicator is lit. A Sync Search can only be initiated by applying a pulse to the rear panel EXT SYNC INPUT (ECL, Logic 0 to 1 transition, > 20nS wide). Sync Search will be repeated if necessary until Sync Gain is achieved.

When Sync Gain is achieved Sync Loss will not occur irrespective of the measured Error rate. The measurement will therefore continue without initiating a Sync Search until a pulse is applied to the EXT SYNC INPUT.

This is of benefit when making measurements on a system suffering irregular long bursts of Errors.

Manual (MAN)

MAN Sync is selected by pressing [SYNC] until the MAN indicator is lit. A Sync Search will only be initiated by pressing [MAN]. Sync Search will be repeated if necessary until Sync Gain is achieved.

When Sync Gain is achieved Sync Loss will not occur irrespective of the measured Error rate. The measurement will therefore continue without a Sync Search being initiated until [MAN] is pressed.

This is of benefit when making measurements on a system suffering irregular long bursts of Errors.

Note



If AUTO is selected and a burst of errors sufficient to fulfil the Sync Loss criteria occurs, then any errors which occur during the Sync Loss/Sync Gain interval will not be included in the measurement result as the Error Counters are disabled during that time.

Error & Error Performance Measurements

The Error measurements count the number of errors occurring during the gating period.

The Error Performance measurements provide analysis of the Error results, and information on the distribution of errors within the Gating period. The analysis gives an indication of the quality of transmission you can expect from your communication link over a period of time.

Error Measurement Menu

The following Error measurement results are available each time an Error measurement is made :-

ERROR RATIO	Ratio of counted errors to number of clock periods in the gating period.
ERROR COUNT	Total number of errors within the gating period.
ERROR SECONDS	Number of seconds which contain at least 1 error.
ERROR FREE SECONDS	Number of seconds which contain 0 errors.

The result displayed in the Results Display corresponds to the Error Measurement selected. All the other measurement results can be displayed in turn by using [ERRORS] to step through the menu.

Error Performance Measurement Menu

The following Error Performance measurement results are available each time an Error measurement is made :-

%UNAVAIL	is the ratio of 1 second intervals when the system was considered "Unavailable" to the total second count during the Gating period. A period of "Unavailability" begins when the BER in each second is worse than 1×10^{-3} for 10 consecutive seconds. Those 10 seconds are considered "Unavailable". The period of "Unavailability" terminates when the BER in each second is better than 1×10^{-3} for 10 consecutive seconds. Those 10 seconds are considered "Available".
%SES	is the ratio of 1 second intervals exhibiting a BER worse than 1×10^{-3} during the "Available" period to the total "Available" second count within the Gating period.
%DM	is the ratio of "Packaged Minutes" exhibiting a BER worse than 1×10^{-6} to the total "Packaged Minute" count within the Gating period. A "Packaged Minute" is a grouping of 60 seconds which does not include Severely Errorred seconds or periods of Unavailability.
%ES	is the ratio of 1 second intervals containing at least 1 error during the "Available" time to the total "Available" second count within the Gating period.

Note



1. When making a % UNAVAIL measurement then a gating period in excess of 10 Seconds is required as the "Availability/Unavailability" decision is based on a 10 Second period.

When making a % DM measurement then a gating period in excess of 1 Minute is required.

2. The Thresholds quoted above for % UNAVAIL, % SES and % DM are the default settings adopted by the HP 3764A at switch-on and correspond to CCITT recommendation G.821. The Thresholds can be changed to other settings in which case the relevant indicator (%UNAVAIL, %SES or %DM) will flash to signify departure from CCITT recommendation.

Basic Error Measurements

The HP 3764A will make Error measurements on Errors derived from two sources :-

- Binary Errors resulting from bit by bit comparison of the received data with an internally generated reference pattern
- External Errors, obtained from an external piece of equipment EG a Line Terminal's Error Monitor.

Binary Errors

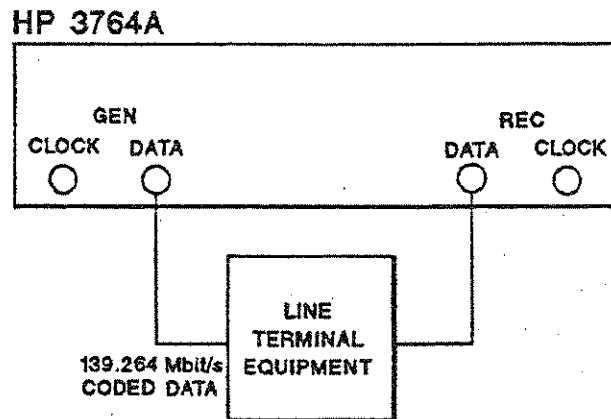

Figure 2-1. Measurement of Binary Errors on 139.264 Mbit/s Coded Data

1. Select the necessary Data Generation parameters :-

Frequency	139M
GEN O/P I/FACE	CMI
Pattern	PRBS (2 ²³ -1)
Error Add	As required

Note



Full details on the method of selection and selection choice can be found in Section 1, Data Generation, Pages 1-10 to 1-15.

2. Select the necessary Error Measurement parameters :-

REC I/P I/FACE	TERM
Frequency	139M (As Data Generation)
Pattern	PRBS (2 ²³ -1 As Data Generation)
Synchronization	AUTO
Error Measurement	ERROR RATIO
Gating Type	As required
Gating Period	As required
Previous/Current	As required
Result	

Note



Full details on the method of selection and selection choice can be found in Section 1, Error Measurement, Pages 1-24 to 1-32.

3. Connect up the equipment as shown in Figure 2-1.

4. Press [START/STOP] to start the Gating Period.

The Error Ratio result will be displayed in the Results Display. Any of the other Error Measurement results can be viewed by pressing [ERRORS] until the appropriate Indicator is lit. Any of the Error Performance Measurement results can be displayed by pressing [ERROR PERFORM] until the appropriate Indicator is lit.

Note



If long term unattended measurements are necessary the measurement results can be Logged to an external printer. In addition External events which are connected to the Auxiliary Input can also be logged to the printer. Full details of Logging to an external or internal printer can be found in Section 1, Printer, Pages 1-46 to 1-56.

External Errors

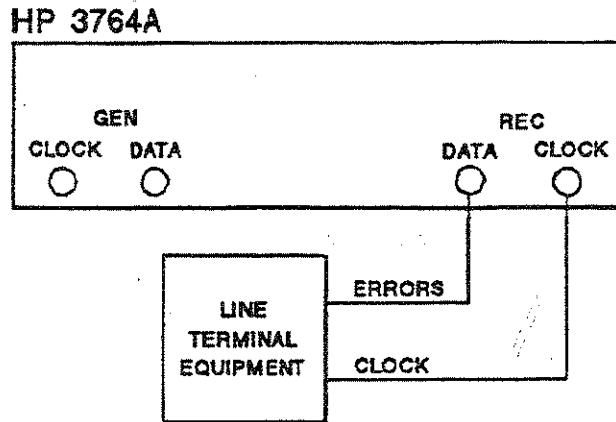

Figure 2-2. Measurement of External Errors

1. Select the necessary Error Measurement parameters :-

REC I/P I/FACE	EXT ERR
Error Measurement	ERROR COUNT
Gating Type	As required
Gating Period	As required
Previous/Current	As required
Result	

Note



1. Synchronization is not required as the Pattern capability of the HP 3764A is not used in this measurement.
2. Full details on the method of selection and selection choice can be found in Section 1, Error Measurement, Pages 1-24 to 1-32.

2. Connect up the equipment as shown in Figure 2-2.
3. Press [START/STOP] to start the Gating Period.

The Error Count result will be displayed in the Results Display. Any of the other Error Measurement results can be viewed by pressing [ERRORS] until the appropriate Indicator is lit. Any of the Error Performance Measurement results can be displayed by pressing [ERROR PERFORM] until the appropriate Indicator is lit.

Note



If long term unattended measurements are necessary the measurement results can be Logged to an external printer. In addition External events which are connected to the Auxiliary Input can also be logged to the printer. Full details of Logging to an external or internal printer can be found in Section 1, Printer, Pages 1-46 to 1-56.

Clock Recovery Tolerance

The Frequency of the HP 3764A GEN DATA OUTPUT is offset and input to the terminal equipment. Error measurements are performed at the terminal equipment Data Output.

Note

An HP 3764A Option 006 is required to carry out this measurement.

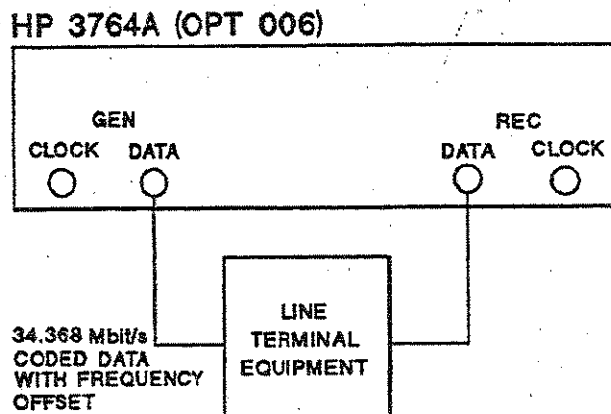

Figure 2-3. 34.368 MHz Clock Recovery Tolerance Measurement

1. Select the necessary Data Generation parameters :-

GEN I/P I/FACE	HDB3
Pattern	PRBS ($2^{23} - 1$)
Frequency Source	INTERNAL
Frequency Rate	34.368 MHz
Frequency Offset	VARIABLE 1

Note

Full details on the method of selection and selection choice can be found in Section 1, Data Generation, Pages 1-10 to 1-15.



2. Select the necessary Error Measurement parameters :-

REC I/P I/FACE	TERM
Frequency Source	INTERNAL (As Data Generation)
Frequency Rate	34.368 MHz (As Data Generation)
Frequency Offset	VARIABLE 1 (As Data Generation)
Pattern	PRBS ($2^{23} - 1$) (As Data Generation)
Synchronization	As required
Error Measurement	ERROR COUNT
Gating Type	As required
Gating Period	As required
Previous/Current	As required
Result	

Note



Full details on the method of selection and selection choice can be found in Section 1, Error Measurement, Pages 1-24 to 1-32.

3. Connect up the equipment as shown in Figure 2-3.
4. Press [START/STOP] to start the gating period.
5. Increase the HP 3764A Frequency Offset and check for errors appearing in the Results Display.

The Error Count result will be displayed in the Results Display. Any of the other Error Measurement results can be viewed by pressing [ERRORS] until the appropriate Indicator is lit. Any of the Error Performance Measurement results can be displayed by pressing [ERROR PERFORM] until the appropriate Indicator is lit.

Note



If long term unattended measurements are necessary the measurement results can be Logged to an external printer. In addition External events which are connected to the Auxiliary Input can also be logged to the printer. Full details of Logging to an external or internal printer can be found in Section 1, Printer, Pages 1-46 to 1-56.

565 Mbit/s Fibre Optic Error Measurement

The HP 3764A provides four 139.264 Mbit/s Data streams to a Multiplexer. Each Data stream is delayed with respect to the others. Error Measurements are made on the Outputs of the Demultiplexer (139.264 Mbit/s).

Note An HP 3764A Option 003 is required to carry out this measurement.

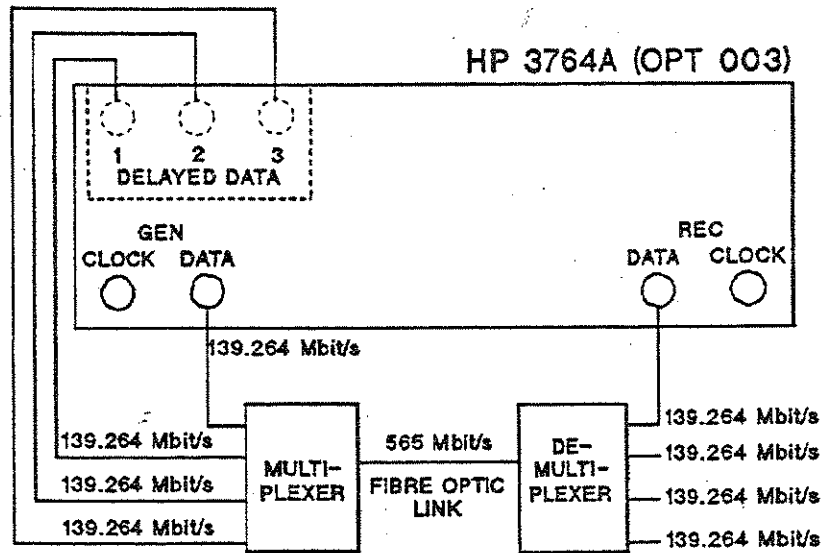

Figure 2-4. 565 Mbit/s Fibre Optic Measurement

1. Select the necessary Data Generation parameters :-

GEN I/P I/FACE	CMI
Pattern	PRBS ($2^{23} - 1$)
Frequency	139.264 MHz
Error Add	As required

Note



Full details on the method of selection and selection choice can be found in Section 1, Data Generation, Pages 1-10 to 1-15.

2. Select the necessary Error Measurement parameters :-

REC I/P I/FACE	TERM
Frequency	139.264 MHz (As Data Generation)
Pattern	PRBS (2 ²³ -1) (As Data Generation)
Synchronization	As required
Error Measurement	ERROR RATIO
Gating Type	As required
Gating Period	As required
Previous/Current	As required
Result	

Note

Full details on the method of selection and selection choice can be found in Section 1, Error Measurement, Pages 1-24 to 1-32.

3. Connect up the equipment as shown in Figure 2-4.
4. Press [START/STOP] to start the gating period.

The Error Ratio result will be displayed in the Results Display. Any of the other Error Measurement results can be viewed by pressing [ERRORS] until the appropriate Indicator is lit. Any of the Error Performance Measurement results can be displayed by pressing [ERROR PERFORM] until the appropriate Indicator is lit.

Note

If long term unattended measurements are necessary the measurement results can be Logged to an external printer. In addition External events which are connected to the Auxiliary Input can also be logged to the printer. Full details of Logging to an external or internal printer can be found in Section 1, Printer, Pages 1-46 to 1-56.

Jitter Measurements

All of the Jitter measurements are based on the pk-pk amplitude of the Jitter. The HP 3764A measures the jitter amplitude by monitoring the maximum phase excursions of the clock signal, about its reference position, during the gating period. The result is displayed in Unit Intervals (UI) PK-PK.

A Jitter Hit occurs when the measured amplitude exceeds a preset threshold. The Jitter Hit threshold is specified in UI PK-PK. Selecting a threshold of 0.5 UI, for instance, results in internal threshold settings of +0.5 UI and -0.5 UI. A Jitter Hit will be registered when either internal threshold is exceeded.

Jitter Measurement Menu

The following Jitter measurements are available each time a Jitter measurement is made :-

PK-PK MAX	is maximum value of pk-pk Jitter measured over the selected gating period.
JITTER HIT COUNT	is the number of times the measured jitter amplitude exceeds a user-set Threshold.
JITTER HIT SECONDS	is the number of seconds in which the measured jitter amplitude exceeds a user-set Threshold.
JITTER HIT FREE SECONDS	is the number of seconds in which the measured jitter amplitude does NOT exceed a user-set Threshold.

The result displayed in the Results Display corresponds to the Jitter measurement selected. All the other Jitter results can be displayed in turn using [JITT MEAS] to step through the menu.

Basic Jitter Measurements

The HP 3764A will make Jitter measurements on 139.264 Mbit/s CMI coded data or on 139.264 Mbit/s Binary clock.

CMI Coded Data

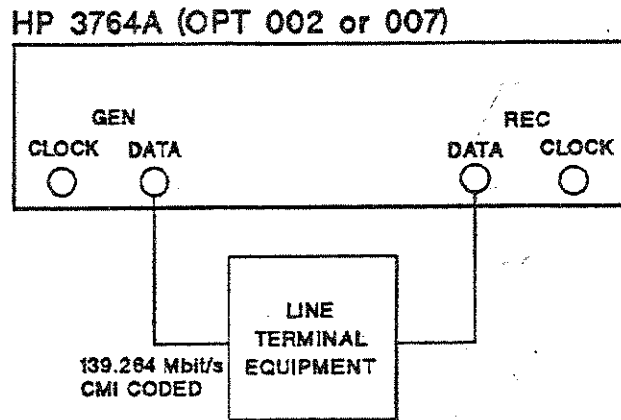

Figure 2-5. Jitter Amplitude Measurement (139.264 Mbit/s CMI Data)

1. Select the necessary Data Generation parameters :-

GEN I/P I/FACE	CMI
Frequency	139.264 Mbit/s
Pattern	PRBS ($2^{23}-1$)

Note



Full details on the method of selection and selection choice can be found in Section 1, Data Generation, Pages 1-10 to 1-15.

2. Select the necessary Jitter Measurement parameters :-

REC I/P I/FACE	TERM
Frequency	139.264 Mbit/s (139M)
Pattern	PRBS (2 ²³ -1)
Jitter Measurement	PK-PK MAX
Amplitude Range	As required
Jitter Reference Clock	INTERNAL
Jitter Filters	As Required
Jitter Gating Type	As Required
Jitter Gating Period	As Required
Current/Previous	As Required
Result	

Note

Full details on the method of selection and selection choice can be found in Section 1, Jitter Measurement, Pages 1-34 to 1-38.

3. Connect up the equipment as shown in Figure 2-5.
4. Press [START/STOP] to start the gating period.

The PK-PK Amplitude result will be displayed in the Results Display.

Note

1. Spectrum analysis of the demodulated Jitter can be made by connecting the rear panel DEMOD JITT O/P to a Spectrum Analyser.
 2. If Jitter Filters : EXTERNAL is selected the Jitter measurement can be made with the user's own filters connected between the DEMOD JITT O/P and the JITT MEAS I/P.
 3. If long term unattended measurements are necessary the measurement results can be Logged to an external printer. In addition External events which are connected to the Auxiliary Input can also be logged to the printer. Full details of Logging to an external or internal printer can be found in Section 1, Printer, Pages 1-46 to 1-56.
-

Binary Clock

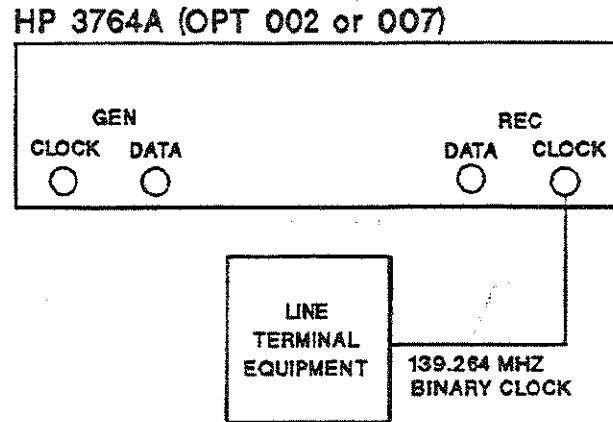

Figure 2-6. Jitter Hit Count (139.264 Mbit/s Binary Clock)

1. Select the necessary Jitter Measurement parameters :-

REC I/P I/FACE	BIN
Frequency	139.264 Mbit/s (139M)
Jitter Measurement	JITTER HIT COUNT
Amplitude Range	As required
Jitter Reference Clock	INTERNAL
Jitter Filters	As Required
Jitter Hit Threshold	As Required
Jitter Gating Type	As Required
Jitter Gating Period	As Required
Current/Previous	As Required
Result	

Note

Full details on the method of selection and selection choice can be found in Section 1, Jitter Measurement, Pages 1-34 to 1-38.

2. Connect up the equipment as shown in Figure 2-6.
3. Press [START/STOP] to start the gating period.

The Hit Count result will be displayed in the Results Display. Any of the other Jitter Measurement results can be displayed by pressing [JITT MEAS] until the appropriate indicator is lit.

Note

1. Spectrum analysis of the demodulated Jitter can be made by connecting the rear panel DEMOD JITT O/P to a Spectrum Analyser.
 2. If Jitter Filters : EXTERNAL is selected the Jitter measurement can be made with the user's own filters connected between the DEMOD JITT O/P and the JITT MEAS I/P.
 3. If long term unattended measurements are necessary the measurement results can be Logged to an external printer. In addition External events which are connected to the Auxiliary Input can also be logged to the printer. Full details of Logging to an external or internal printer can be found in Section 1, Printer, Pages 1-46 to 1-56.
-

Jitter Tolerance Measurement

A 139.264 Mbit/s CMI Coded Data stream modulated with Jitter at a user specified frequency is applied at the terminal equipment data input. The data output is monitored for Binary Errors. The amplitude of Jitter is varied to find the level of Jitter at which Errors begin to occur. This level represents the Maximum level of Tolerable Input Jitter (MTIJ) for that particular Jitter frequency. The test is repeated at different Jitter frequencies thus characterizing the terminal equipment for Jitter Tolerance.

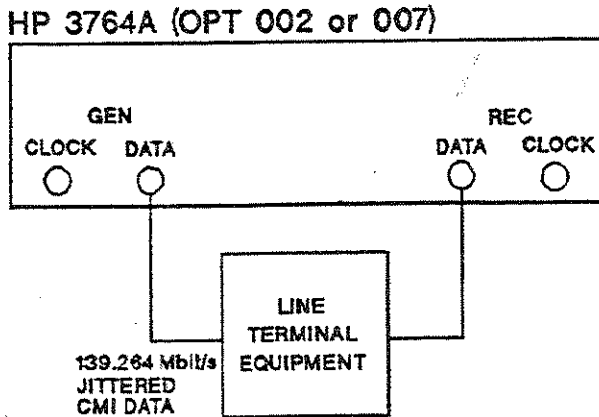

Figure 2-7. Jitter Tolerance Measurement

1. Select the necessary Jitter Generation parameters :-

GEN O/P I/FACE	CMI
Pattern	PRBS (2 ²³ -1)
Frequency	139.264 MHz
Jitter Modulation	INTERNAL
Jitter Mask	As Required

Note



Full details on the method of selection and selection choice can be found in Section 1, Jitter Generation, Pages 1-16 to 1-18.

2. Select the necessary Error Measurement parameters :-

REC I/P I/FACE	TERM
Frequency	139.264 Mbit/s (As Jitter Generation)
Pattern	PRBS (2 ²³ -1) (As Jitter Generation)
Error Measurement	ERROR COUNT
Synchronization	As required
Error Gating Type	As Required
Error Gating Period	As Required
Current/Previous	As Required
Result	

Note



Full details on the method of selection and selection choice can be found in Section 1, Error Measurement, Pages 1-24 to 1-33.

3. Connect up the equipment as shown in Figure 2-7.
4. Press [START/STOP] to start the gating period.

The Error Count result will appear in the results display. The generated jitter amplitude can be viewed by pressing [FREQ/AMP].

The generated jitter amplitude can be varied using [▲] or [▼] and the Error Count result monitored until Errors appear. This point indicates the Maximum level of Tolerable Input Jitter (MTIJ).

Repeat the measurement at different Jitter frequencies to characterise the terminal equipment Jitter Tolerance performance.

Note



If long term unattended measurements are necessary the measurement results can be Logged to an external printer. In addition External events which are connected to the Auxiliary Input can also be logged to the printer. Full details of Logging to an external or internal printer can be found in Section 1, Printer, Pages 1-46 to 1-56.

Jitter Transfer Measurement

A 139.264 Mbit/s CMI Coded Data stream modulated with Jitter at a user specified frequency is applied at the terminal equipment data input. A Jitter amplitude measurement is made at the terminal equipment data output. The difference between the generated jitter amplitude and the measured jitter amplitude is the Jitter Gain of the terminal equipment :-

$$20 \text{LOG}_{10} \frac{\text{Output Jitter}}{\text{Input Jitter}} \text{dB}$$

The Jitter Transfer Function comprises of Jitter Gain measurements at a number of frequencies across the jitter bandwidth. Maximum Jitter Transfer characteristics have been specified by CCITT.

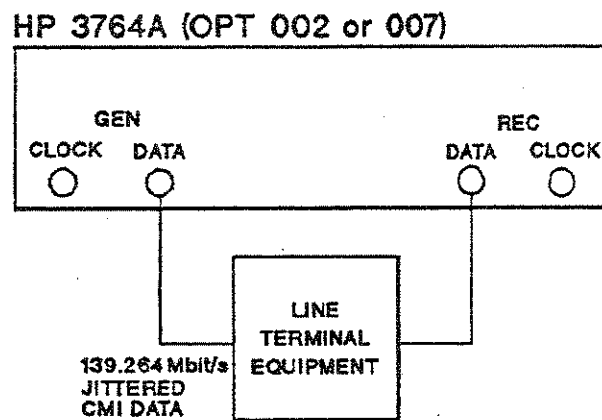

Figure 2-8. Jitter Transfer Measurement

1. Select the necessary Jitter Generation parameters :-

GEN O/P I/FACE	CMI
Pattern	PRBS (2 ²³ -1)
Frequency	139.264 MHz
Jitter Modulation	INTERNAL
Jitter Frequency	As Required
Jitter Amplitude	As Required

Note

Full details on the method of selection and selection choice can be found in Section 1, Jitter Generation, Pages 1-16 to 1-18.



2. Select the necessary Jitter Measurement parameters :-

REC I/P I/FACE	TERM
Frequency	139.264 Mbit/s (As Jitter Generation)
Pattern	PRBS (2 ²³ -1) (As Jitter Generation)
Jitter Measurement	PK-PK MAX
Amplitude Range	As Required
Jitter Reference Clock	INTERNAL
Jitter Filters	As Required
Jitter Gating Type	As Required
Jitter Gating Period	As Required
Current/Previous	As Required
Result	

Note

Full details on the method of selection and selection choice can be found in Section 1, Jitter Measurement, Pages 1-34 to 1-38.

3. Connect up the equipment as shown in Figure 2-8.
4. Press [START/STOP] to start the gating period.

The measured Jitter amplitude will appear in the results display. The generated jitter frequency can be viewed by pressing [FREQ/AMP] and varied using [▲] or [▼].

Note

1. If low frequency Jitter (<200 Hz) is to be measured then it is necessary to select; Jitter Reference Clock : EXTERNAL and connect a 139.264 MHz clock to the HP 3764A rear panel JITT REF CLK I/P.
 2. If long term unattended measurements are necessary the measurement results can be Logged to an external printer. In addition External events which are connected to the Auxiliary Input can also be logged to the printer. Full details of Logging to an external or internal printer can be found in Section 1, Printer, Pages 1-46 to 1-56.
-

De-Multiplexer Jitter Tolerance Measurement

Jitter testing of a De-Multiplexer requires an HP 3764A Option 007 (THRU Data) and an HP 3784A Digital Transmission Analyser.

The HP 3784A provides a 34.368 Mbit/s HDB3 coded PRBS data stream to one input of a Multiplexer. The Multiplexer data output, 139.264 Mbit/s CMI coded PRBS data, is applied to the Thru Data, DATA I/P of the HP 3764A. Jitter modulation is added to the 139.264 Mbit/s data by the HP 3764A. The jittered 139.264 Mbit/s data is applied to the De-Multiplexer input. A Jitter Tolerance or Jitter Transfer measurement is now performed at the appropriate De-Multiplexer output.

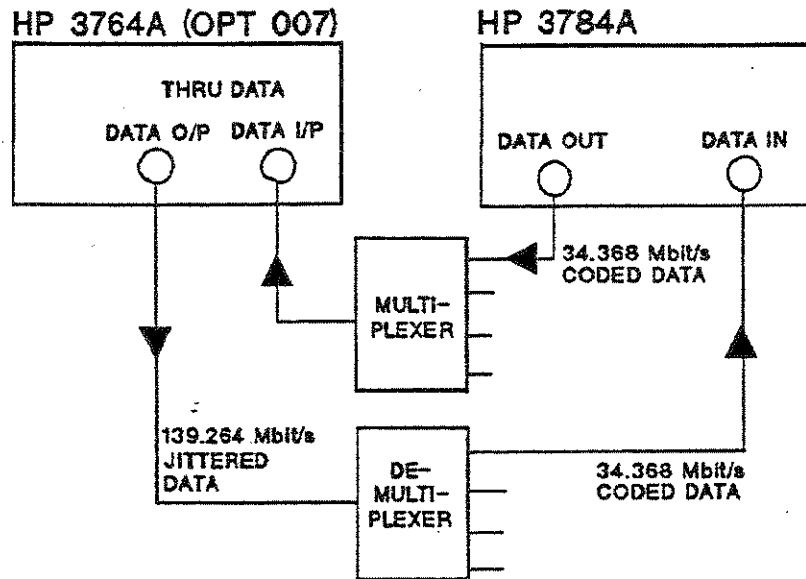

Figure 2-9. De-Multiplexer Jitter Tolerance Measurement

1. Select the necessary HP 3784A Data generation parameters :-

Data Out	HDB3
Pattern	PRBS ($2^{15}-1$)
Clock Rate	34.368 MHz

Note



Full details on the method of selection and selection choice can be found in the HP 3784A Operating & Calibration manual.

2. Select the necessary HP 3764A Thru Data parameters :-

REC I/P I/FACE	TERM
Frequency	139.264 Mbit/s
Pattern	PRBS (2 ²³ -1)
Jitter Modulation	INTERNAL
Jitter Frequency	As Required
Jitter Amplitude	As Required

3. Configure Thru Data for CMI by pressing [CONFIGURATION], and [◀] & [▲] until CMI is flashing in the bottom row of the Parameters display.

Note

Full details on the method of selection and selection choice can be found in Section 1, Thru Data, Pages 1-19 to 1-22.

4. Select the necessary HP 3784A Error Measurement parameters :-

Data In	HDB3 (As Data Generation)
Clock Rate	34.368 MHz (As Data Generation)
Measurement	Rx Bit Error :COUNT
Gating Type	As Required
Gating Period	As Required

3. Connect up the equipment as shown in Figure 2-9.
4. Press [START/STOP] to start the measurement.

The Measurement in progress will take the form of a Jitter Tolerance measurement with the HP 3764A providing the Jitter generation and the HP 3784A the Error measurement.

The HP 3764A generated jitter amplitude can be varied using [▲] or [▼] and the Error Count result on the HP 3784A Measurements page monitored until Errors appear. This point indicates the Maximum level of Tolerable Input Jitter (MTIJ).

Repeat the measurement at different Jitter frequencies to characterise the De-Multiplexer Jitter Tolerance performance.

Note

1. A Jitter Transfer measurement could also be carried out by using the HP 3784A to measure the Jitter amplitude at the De-Multiplexer output and the HP 3764A to provide Jitter generation.
 2. If long term unattended measurements are necessary the measurement results can be Logged to an external printer. In addition External events which are connected to the Auxiliary Input can also be logged to the printer. Full details of Logging to an external or internal printer can be found in Section 1, Printer, Pages 1-46 to 1-56.
-

Display/Error Messages

During operation of the HP 3764A certain Display/Error messages may appear on the Parameters display. These messages are accompanied by an audible " BEEP " to gain your attention. The message is cancelled by the next keystroke or the next HP-IB command received. If the message is caused by an invalid keystroke, it will be cancelled after 3 Seconds. Table A-1 contains a full list of Display/Error messages and their meaning.

Table A-1. Display/Error Messages

Displayed Message	Meaning
SELF TEST	Self test of the microprocessor system and associated circuitry is taking place at power-on.
ROM TEST FAILED	Test of ROM failed during power-on Self Test
RAM TEST FAILED	Test of RAM failed during power-on Self Test.
CALIBRATION TBL CORRUPT	Calibration table for the Synthesizer was found to be corrupt during power-on Self Test (Opts 006, 007 Only).
CALIBRATION TBL DEFAULT	The Synthesizer calibration cycle has suffered a power interruption during the power-on Self Test (Opts 006, 007 Only).
SYNTHESIZER FAILED	Synthesizer hardware test has failed during power-on Self Test (Opts 006, 007 Only).
POWER LOSS (C) HPLTD 86	Power loss has occurred but power is now restored.
NOT ALLOWED WHEN GATING	Measurement configuration changes are not allowed while the HP 3764A is Gating.
NOT ALLOWED KYBRD LOCKED	No front panel settings can be changed while keyboard lock is asserted.
NOT ALLOWED FOR PRESET 0	Measurement Preset location 0 cannot be used for storage of settings.
NOT ALLOWED T.O.+CNTRLER	Talk Only mode is not allowed when a Controller is connected to the HP-IB.
NOT ALLOWED PRNTR IN USE	The last action attempted is not allowed while the Printer is being used.
NOT ALLOWED TAPE IN USE	The last action attempted is not allowed while the Tape cartridge Unit is being used.
NOT ALLOWED HP-IB IN USE	The last action attempted is not allowed as the HP-IB is already being used.

**Table A-1. Display/Error Messages
Continued**

Displayed Message	Meaning
NOT ALLOWED NO OPTION	The option required to comply with the last request is not fitted.
NOT ALLOWED PRSET LOCKED	Measurement Preset Store is not allowed as Preset Lock is asserted.
TAPE ACTION COMPLETED	The Tape Cartridge Unit action requested has been completed and the next action can be requested.
OPTION MISMATCH	SETTINGS Recall is invalid because the option structure of the HP 3764A does not match that on the Tape Cartridge.
SETTINGS MISMATCH	SETTINGS Recall is invalid because the front panel structure of the HP 3764A does not match that on the Tape Cartridge IE. Firmware change.
O/P BUFFER OVERFLOW	Too much Data has been generated too quickly for the External Printer, Internal Printer or Tape Cartridge Unit.
CARTRIDGE OUT	No Tape Cartridge inserted in the Tape drive.
TAPE WRITE PROTECTED	New data cannot be stored on the Tape Cartridge until the Write-Protect tab is changed.
TAPE MOTOR STALL	The motor, of the Tape Cartridge Unit, has stalled. Bad Tape Cartridge or Tape transport problem.
TAPE NOT INITIALISED	Attempt to Store Data or Settings not successful as the Tape Cartridge has not been Initialised.
WRONG TAPE FILE TYPE	DATA and SETTINGS cannot be mixed on one Tape Cartridge or the wrong type of Tape Cartridge has been inserted.
TAPE VERIFY ERROR	Data not correctly verified. Bad Tape Cartridge, try re-initialising the Tape Cartridge.
TAPE FULL	Tape Cartage is full or Tape has run-off the end.
NO RECORDINGS ON TAPE	Tape Cartridge is correctly Initialised but no DATA/SETTINGS have been recorded IE. there is nothing to Recall.
TAPE BROKEN	Tape has broken or run-off the end.
OPTION LINKS INVALID	The internal links defining the option present are set to an invalid state. Contact your nearest HP Sales & Service office.
NON VOLATILE MEMORY LOST	At power-on the Non Volatile Memory was corrupt. HP 3764A adopts Default Settings and the Real Time Clock is reset to :- 00 00 00 ; 1 JAN 1984.
NVM RESET NEW OPTION	Displayed at power-on if the option structure of the HP 3764A has been changed. HP 3764A adopts Default Settings and the Real Time Clock is reset to :- 00 00 00 ; 1 JAN 1984.
NVM LOST BAD POWER DOWN	NVM was lost during last power down. HP 3764A adopts Default Settings and the Real Time Clock is reset to :- 00 00 00 ; 1 JAN 1984.
NVM RESET NEW FIRMWARE	Displayed at power-on if new firmware has been installed in the HP 3764A. HP 3764A adopts Default Settings and the Real Time Clock is reset to :- 00 00 00 ; 1 JAN 1984.

**Table A-1. Display/Error Messages
Continued**

Displayed Message	Meaning
CANT SEND TO SYNTHESIZER	The Synthesizer processor hardware has failed (Opts 006, 007 Only). Contact your nearest HP Sales & Service office.
NO RESPONSE FROM SYNTH	The Synthesizer processor hardware has failed (Opts 006, 007 Only). Contact your nearest HP Sales & Service office.
BAD MESSAGE FROM SYNTH	The Synthesizer processor hardware has failed (Opts 006, 007 Only). Contact your nearest HP Sales & Service office.
SYNTHESIZER CANT LOCK	The Synthesizer has failed to lock to the required frequency (Opts 006, 007 Only). Contact your nearest HP Sales & Service office.

Default Settings

The following actions will cause the HP 3764A to adopt the Default Settings :-

Press [RECALL] until 0 appears in the Preset display.

Issue a Device Clear via the HP-IB.

Issue a Selective Device Clear via the HP-IB.

Issue "RCL 0" via the HP-IB.

Note



In the event of a Power down the current front panel settings are stored in Non Volatile Memory (NVM). When power is restored (Power Up) the HP 3764A adopts the settings stored in NVM not the Default Settings.

In the event of an NVM failure the HP 3764A will adopt the Default Settings and reset the HP-IB Address to 3. In addition the Real Time Clock setting will be lost and the Clock will be reset to :-

Time 00 00 00

Date 1 JAN 1984

Table B-1. Default Settings

Function	Default Setting	Function	Default Setting
DATA GENERATION		ERROR MEASUREMENT	
GEN. O/P Interface	CMI	REC. I/P Interface	CMI/TERM
Frequency Source	INTERNAL	REC. Clock Polarity	TRUE
Frequency Rate	139.264 Mbit/s	REC. Data Polarity	TRUE
Pattern	PRBS	Frequency Source	INTERNAL
Error Add	OFF	Frequency Rate	139.264 Mbit/s
		Pattern	PRBS
THRU DATA		Synchronization	AUTO
Thru Data	OFF	Error Measurement Type	ERROR RATIO
Input Format	CMI	%UA & %SES Threshold	10 ⁻³
Binary Clock Polarity	TRUE	%DM Threshold	10 ⁻⁶
		Gating Type	MANUAL
JITTER GENERATION		Gating Period	1 SECOND
Jitter Generator	OFF	Previous/Current Period	PREVIOUS
Mask Size	4	Start/Stop Gating	STOP
Mask Contents	1 200 Hz 10 UI		
	2 500 Hz 10 UI	PRINTER (External)	
	3 10 kHz 0.5 UI	Results Configuration	ALW EHS OFF
	4 3.5 MHz 0.5 UI		

**Table B-1. Default Settings
Continued**

Function	Default Setting	Function	Default Setting
JITTER MEASUREMENT		PRINTER (Internal)	
Jitter Measurement	OFF	Results Configuration	ALW EHS OFF
Amplitude Range	OFF	Print	OFF
Reference Clock Source	INTERNAL	Selected Results (Error)	EPNNNN ENNNN
Jitter Threshold	1.00 UI	Selected Results (Jitter)	JMNNNN
Jitter Filters	OFF		
Jitter Gating Mode	REPETITIVE	TAPE CARTRIDGE	
Jitter Gating Period	1 SECOND	Results Configuration	ALW EHS OFF
Previous/Current Period	PREVIOUS	Initialise	OFF
		Store	OFF
MEASUREMENT PRESET		Recall	OFF
Location	0		
Keyboard Lock	OFF	MISCELLANEOUS	
		Audio	OFF
FLAGS		SRQ Enable/Disable	RQS ON
	CLEARED	SRQ Response Mask	32 (ERROR)
AUXILIARY INPUTS			
Analog Threshold	+5.0 V		

Index

A

AI Flag (AIS), 1-42
AIS, 1-15, 1-29
Alternate Word, 1-14
 Changeover Rate, 1-14
 Input, 1-14
Automatic Equalization, 1-24
Automatic Synchronization, 1-29, 2-2
Auxiliary Inputs, 1-43
 Analogue Threshold, 1-44

B

Binary Data
 GEN O/P Interface, 1-12
 REC I/P Interface, 1-24
Binary Error Measurement, 2-5

C

CL Flag (Clock Loss), 1-42
Clock Recovery Tolerance, 2-8
Configuring Results
 External Printer, 1-48
 Internal Printer, 1-51
 Tape Cartridge Unit, 1-59

D

Data Generation, 1-6, 1-10
Date, 1-45
Default Settings, 1-3, B-1
Degraded Minutes, 1-32, 2-4
Delayed Data, 1-23
De-Multiplexer Jitter Tolerance, 2-21
Display/Error Messages, A-1
DL Flag (Data Loss), 1-42

E

Elapsed Time, 1-8, 1-30-32, 1-37
Equalization, 1-24
Error Add, 1-5, 1-15
Error Count, 2-4
Error Free Seconds, 2-4
Error/Hits Indicator, 1-24, 1-35
Error Measurement, 1-6, 1-24
 565 Mbit/s Fibre Optic Link, 2-10
 Binary Errors, 2-5

 Clock Recovery Tolerance, 2-8
 Error Count, 1-30
 Error Free Seconds, 1-30
 Error Ratio, 1-30
 Error Seconds, 1-30
 External Errors, 2-7
 Manual Gating, 1-30
 Repetitive Gating, 1-31
 Single Gating, 1-31
Error Performance Measurements, 1-32
 Degraded Minutes, 1-32
 Errored Seconds, 1-32
 Severely Errored Seconds, 1-32
 Thresholds, 1-32
 Unavailability, 1-32
Error Ratio, 2-4
Errored Seconds, 1-32, 2-4
Error Seconds, 2-4
External Clock I/P
 Termination Level (Opts 006, 007), 1-11, 1-27
 Termination Level (Std, Opts 001, 002, 003),
 1-10, 1-25
External Printer
 Configuring Results, 1-7, 1-48
 Connecting, 1-5, 1-47
 Printing Results, 1-8, 1-49
External Synchronization, 1-29, 2-3

F

Fibre Optic Error Measurement, 2-10
Flags, 1-42
 AIS, 1-42
 Clock Loss, 1-35, 1-42
 Data Loss, 1-30, 1-42
 Jitter Receiver Out Of Lock, 1-42
 Sync Loss, 1-29-30, 1-42
 Unavailable, 1-42
Frequency Menu, 1-10, 1-25
Frequency Selection
 External (Opts 006, 007), 1-11, 1-27
 Jitter Generation, 1-16
 Jitter Measurements, 1-34
 Offsets (Opts 006, 007), 1-11, 1-26
 (Opts 006, 007), 1-11, 1-26
 (Std, Opts 001, 002, 003), 1-10, 1-25
Front Panel Connectors

GEN CLOCK OUTPUT, 1-10
GEN DATA OUTPUT, 1-10
GEN EXT CLOCK INPUT, 1-10, 1-25
JITTER MOD I/P, 1-18, 1-20
REC CLOCK INPUT, 1-24
REC DATA INPUT, 1-24
REC MONITOR DATA INPUT, 1-24
Thru Data CLOCK INPUT, 1-21
Thru Data DATA INPUT, 1-21
Thru Data DATA OUTPUT, 1-21

G

Gating Period, 2-2
 Elapsed Time, 1-8, 1-30-32, 1-37
 Manual, 1-30, 1-33, 1-37
 Previous/Current, 1-32, 1-38
 Repetitive, 1-30, 1-33, 1-37
 Single, 1-30, 1-33, 1-37
GEN O/P Interface
 Binary Termination Level (Opt 006), 1-12
 Binary Termination Level (Std, Opts 001, 002,
 003, 007), 1-12
 CMI, 1-12
 HDB3, 1-12
 Jitter Generation, 1-16
 NRZ, 1-12
 RZ, 1-12

I

Internal Printer
 Configuring Results, 1-51
 Paper Roll Replacement, 1-55
 Printing Results, 1-53
 Ribbon Replacement, 1-56
 Select Printed Results, 1-52

J

Jitter Generation, 1-16
 External Modulation, 1-18
 External Modulation Amplitude Range, 1-18
 Frequency Selection, 1-16
 GEN O/P Interface, 1-16
 Internal Jitter Mask, 1-17
 Internal Modulation, 1-16
 Internal Modulation Amplitude Range, 1-16
 Thru Data, 1-19
Jitter Hit Count, 2-12
Jitter Hit Free Seconds, 2-12
Jitter Hit Seconds, 2-12
Jitter Measurement, 1-34
 Amplitude (CMI Data), 2-13
 Amplitude Range, 1-35
 Binary Clock (Hit Count), 2-15
 Filters, 1-36

Frequency Selection, 1-34
Hit Count, 1-35
Hit Free Seconds, 1-35
Hit Seconds, 1-35
Hit Threshold, 1-36
Jitter Tolerance, 2-17
Jitter Transfer, 2-19
Manual Gating, 1-37
Overrange, 1-35
Pk-Pk Max, 1-35
REC I/P Interface, 1-34
Reference Clock, 1-36
Repetitive Gating, 1-38
Single Gating, 1-38
Jitter PK.PK MAX, 2-12
Jitter Tolerance Measurement
 De-Multiplexer, 2-21

K

Keyboard Lock, 1-39

M

Manual Synchronization, 1-29, 2-3
Measurement Interval, 2-2
Measurement Messages
 Printer, 1-46
 Tape Cartridge Unit, 1-57
Measurement Preset, 1-39
 Lock, 1-39
 Recall, 1-41
 Store, 1-5, 1-7, 1-40

O

OL Flag (Jitter Receiver Out Of Lock), 1-42

P

Paper Replacement, 1-55
Pattern
 AIS, 1-15, 1-29
 Alternate Word, 1-14
 PRBS, 1-13, 1-27
 Word, 1-13, 1-28
Power Down/Power Up, B-1
PRBS, 1-13, 1-27
Printer
 External, 1-47
 Internal, 1-51
 Measurement Messages, 1-46

R

Real Time Clock
 Date, 1-45
 Time, 1-45
Rear Panel Connectors

ALT WORD I/P, 1-14
AUX INPUTS, 1-43
DATA O/P 1, 1-23
DATA O/P 2, 1-23
DATA O/P 3, 1-23
DEMOD JITT O/P, 1-35
ERROR/HITS O/P, 1-30, 1-35, 1-42
EXT SYNC I/P, 1-29
GEN CLK MON O/P, 1-10
GEN TRIG O/P, 1-13
JITT MEAS I/P, 1-34, 1-36
JITT REF CLK I/P, 1-34, 1-36
REC CLK O/P, 1-24
REC TRIG O/P, 1-27, 1-29

Recall

Measurement Preset Location, 1-7, 1-41
Stored Data (Tape Cartridge Unit), 1-62
Stored Settings (Tape Cartridge Unit), 1-62

REC I/P Interface

Binary Clock Termination Level (Opt 006 Only), 1-24
Binary Data Termination Level (Opt 006 Only), 1-24
BIN (Opt 006 Only), 1-24
BIN (Std, Opts 001, 002, 003, 007), 1-24
EXT ERR, 1-25
Jitter Measurement, 1-34
MON, 1-24
TERM, 1-24

Ribbon Replacement, 1-56

S

Severely Errorred Seconds, 1-32, 2-4
SL Flag (Sync Loss), 1-42

Store

Data (Tape Cartridge Unit), 1-60
Measurement Preset Location, 1-7, 1-40
Settings (Tape Cartridge Unit), 1-62

Synchronization

AUTO, 1-29, 2-2
EXT, 1-29, 2-3
MAN, 1-29, 2-3

T

Talk Only Mode, 1-7, 1-48

Tape Cartridge Unit

Configuring Results, 1-59
Data Storage, 1-60
Measurement Messages, 1-57
Recall Stored Data, 1-62
Recall Stored Settings, 1-62
Settings Storage, 1-62
Tape Care, 1-63
Tape Full, 1-61
Tape Initialization, 1-57
Tape Insertion/Removal, 1-62
Tape Life, 1-63
Tape Motor Stall, 1-61
Tape Verify, 1-61
Tape Write Protection, 1-63

Thru Data, 1-19

Configure, 1-21
Enable, 1-21
External Jitter Amplitude Range, 1-20
External Jitter Modulation, 1-20
Internal Jitter Amplitude Range, 1-19
Internal Jitter Mask, 1-19
Internal Jitter Modulation, 1-19
Overflow Indication, 1-21

Time, 1-45

U

UA Flag (Unavailable), 1-42
Unavailability, 1-32, 2-4

W

Word, 1-13, 1-28